

EQUATOR[®]
ADVANCED Appliances ≡

Owner's Manual

Dishwashers

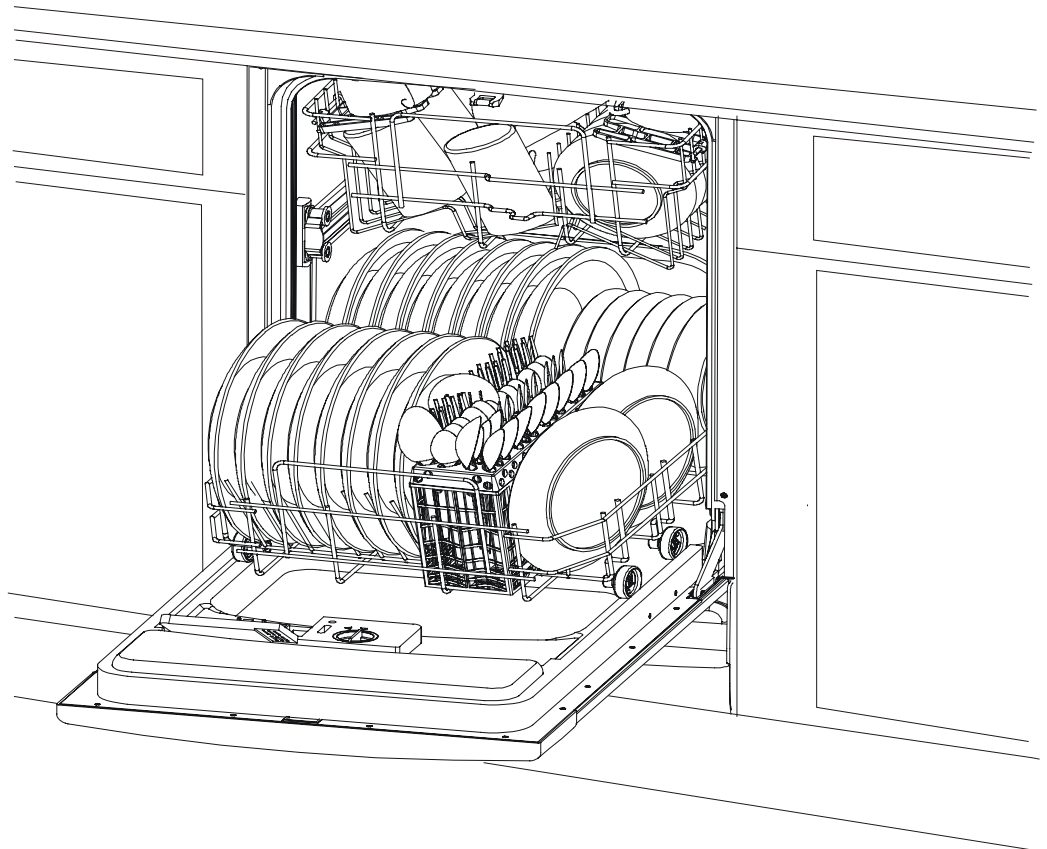

Model SB 924 & WB 924

SAVE THESE INSTRUCTIONS

Dishwasher Features1
Safety Information2

Operating Instructions

Control Panel3
Turning On the Appliance.4
Dishwasher Features4
Wash Cycle Table5
Detergent.6
Rinse Aid.6
Loading the Dishwasher Rack.7
Silverware Basket8
Filtering System.8

User–Maintenance Instructions

Care and Cleaning.9
Troubleshooting Tips 10, 11

WARRANTY INFORMATION

Your Equator appliance is protected by this warranty under normal, personal, family or household use (1 Year), and limited commercial use (90 days) in the USA and Canada.

WARRANTY

Equator Corporation undertakes to the consumer-owner to repair or, at Equator Corporation's option, to replace any part of this product which proves to be defective in workmanship or material under normal personal, family or household use, in the USA and Canada, for a period of one year from the date of original purchase.

For commercial use, the product is warranted for a period of 90 days.

During this period, Equator Corporation will provide all labor and parts necessary to correct such defect, free of charge, if the appliance has been installed and operated in accordance with Equator Corporation's written instructions with the appliance. Ready access to the appliance, for service, is the responsibility of the consumer-owner.

EXCLUSIONS

In no event shall Equator Corporation be liable for incidental or consequential damages or for damages resulting from external causes such as abuse, misuse, incorrect voltage or acts God.

This warranty does not cover service calls which do not involve defective workmanship or materials covered by this warranty. Accordingly, diagnosis and repair costs for a service call which does not involve defective workmanship or materials will be the responsibility of the consumer-owner.

Specifically, the following work is not covered under warranty and does not constitute warranty work:

- . Installation – e.g. improper hook-up or leveling
- . Maintenance – e.g. cleaning of air and/or water filter
- . Damage – e.g. Replacing broken door handle

Most work is covered. The defining factor is, has the machine malfunctioned (Equator is responsible) or has the customer omitted or done something to cause machine to malfunction (customer is responsible). Some States do not allow the exclusion or limitation of incidental or consequential damages, so the above limitation or exclusion may not apply to you.

WARRANTY SERVICE

This warranty is given by:
Equator Corporation,
Equator Plaza,
2801 W. Sam Houston Pkwy. N.,
Houston, TX 77043-1611.

Service under this warranty must be obtained by the following steps, in order:

Call an Equator Corporation Authorized Service Agent (obtain number of nearest agent from your dealer or by calling Equator Service at 1-800-776-3538). Under normal circumstances, Service will be provided during regular business hours (9:00 a.m. to 5:00 p.m. weekdays).

GENERAL

Since it is responsibility of the consumer-owner to establish the warranty period by verifying the original purchase date, Equator Corporation recommends that a receipt, delivery slip or some other appropriate payment record be kept for that purpose.

Remember to send in your Warranty Registration Card so that a proof of your purchase exists with Equator. This warranty gives you specific legal rights, and you may also have other rights which vary from State to State.

Corporate Office

EQUATOR CORPORATION
Equator Plaza
2801 W. Sam Houston Pkwy. N.
Houston, TX 77043-1611
Tel: 713-464-3422 - Fax: 713-464-2151
Tel: 800-776-3538

Dishwasher Features

The electric dishwasher of this model, based on the philosophy of technology is based on human being, besides the common characteristics of other household dishwashers, it has its own specialties:



Remaining time indication

The length of time the programme has left to run will be clearly displayed in the text window, leaving you in no doubt as to when the programme will end and you can go out.



Overflow protection

Your dishwasher has an overflow protection program which could automatically shut off the inlet valve and start the drain pump if the water Overflows.



Intelligent Control System

The intelligent control system could be adaptive to different conditions, such as temperature and voltage, then correct the remaining time automatically.



Memory Function

The memory function could automatically set the frequently used program as current program, it make operation much more easier.



Time Delay Feature

This allows the start of the programme to be delay between 1 and 9.5 hours, enabling you to benefit fully from cheaper electricity! Or just to benefit from the convenience of the programming finishing when you want to.



Error Alarm

Fault codes display would inform the user of abnormal status of the machine.



Stainless Steel Tub

You need not worry about stain of tub.



Language Display

Your dishwashers have 5 language which can display the information in your desired language.



Adjustable Upper Basket

Even if the dishware are abnormality, you can load them by adjust the upper basket.



Rinse Aid Warning Indicator

If the rinse aid are running low, there will be clearly displayed on the panel alerting you to top them up, to ensure that the machine continues to operate at optimum performance.



Broad Applied Voltage

The broad scope of the applied voltage, reduce the code of electric condition.



12 Place Settings

Be sufficient for normal use.



7 Wash Programs

You can choose desired program according to the soiled level. Such as, intensive wash, normal wash, economy, rinse, glass, rapid and pre-wash etc, then you can change temperature of wash.



Temperature display

Display the wash temperature at any moment. If you know the temperature of water, you will prevent from scalding when you open the door.



NOTE:

The manufacturer, following a policy of constant product development, may make modifications without giving prior notice.

IMPORTANT SAFETY INFORMATION

READ ALL INSTRUCTIONS BEFORE USING

WARNING!

When using your dishwasher, follow the below basic precautions.

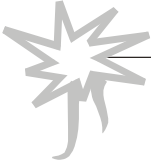

WARNING! HYDROGEN GAS IS EXPLOSIVE

Under certain conditions, Hydrogen gas may be produced in a hot-water system that has not been used for two weeks or more. **HYDROGEN GAS IS EXPLOSIVE.**
If the hot-water system has not been used for such a period, before using the dishwasher turn on all hot-water faucets and let the water flow from each for several minutes. This will release any accumulated hydrogen gas. As gas is flammable, do not smoke or use an open flame during this time.



GROUNDING INSTRUCTIONS

- This appliance must be grounded. In the event of a malfunction or breakdown, grounding will reduce the risk of electric shock by providing a path of least resistance of electric current. This appliance is equipped with a cord having an equipment-grounding conductor and a grounding plug. The plug must be plugged into an appropriate outlet that is installed and grounded in accordance with all local codes and ordinances.

WARNING!

- Improper connection of the equipment-grounding conductor can result in a risk of electric shock. Check with a qualified electrician or service representative if you are in doubt whether the appliance is properly grounded. Do not modify the plug provided with the appliance ;If it is not fit for the outlet .have a proper outlet installed by a qualified electrician.



WARNING! PROPER USE

- Do not abuse, sit on, or stand on the door or dish rack of the dishwasher.
- Do not touch the heating element during or immediately after use.
- Do not wash plastic items unless they are marked dishwasher safe or the equivalent. For plastic items not so marked, check the manufactures recommendations.
- Use only detergent and rinse additives designed for an automatic dishwasher. Never use soap , laundry detergent, or hand washing detergent in your dishwasher. Keep these products out of children.
- Keep child away from detergent and rinse aid, keep child away from the open door of the dishwasher, there could still be some detergent left inside.
- The door should not be left in the open position since this could present a tripping hazards.
- During installation, the power supply must not be excessively or dangerously bent or flattened.
- To reduce the risk os injure, do not allow children to play in or on a dishwasher.
- Do not operate your dishwasher unless all enclosure panels are properly inplace. Open the door very carefully if the dishwasher is operating, there is a risk of water squirting out.
- Do not place any heavy objects of stand on the door when it is open. The appliance could tip forward.
- When loading items to be washed:
 - 1) Locate sharp items so that they are not likely to damage the door seal;
 - 2) Load sharp knives with the handles up to reduce the risk of cut-type injuries.
- When using your dishwasher, you should prevent plastic item from contacting with heating element.
- If the supply cord is damaged, it must be replaced by the manufacturer or its service agent or a similarly qualified person in order to avoid a hazard.
- Please dispose of packing materials properly.
- Use the dishwasher only for its intended function.
- Remove the door to the washing compartment when removing an old dishwasher from service or discarding it.
- Do not tamper with controls.

READ AND FOLLOW THIS SAFETY INFORMATION CAREFULLY

SAVE THESE INSTRUCTIONS

OPERATING INSTRUCTIONS

IMPORTANT!

To get the best performance from your dishwasher, read all operating instructions before using it for the first time.

Control Panel

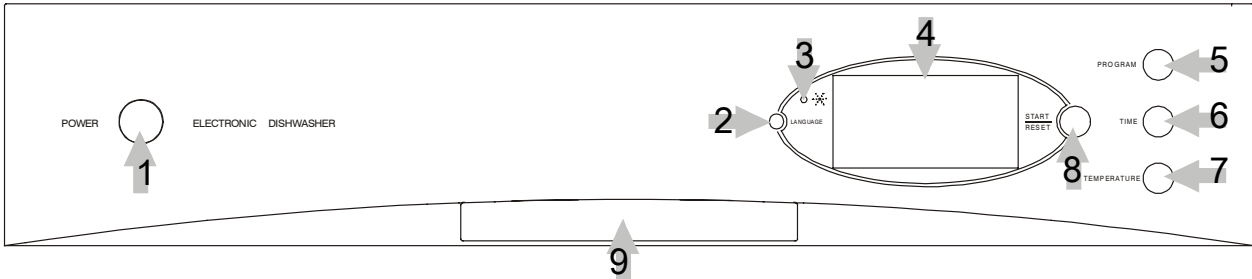

- 1 Power Switch: Turn on/off the power supply.
- 2 Language Button: Select English, Spanish, French, Italian, and German by pressing the button.
- 3 Rinse Aid Warning light: Add more rinse aid as the indicator on the front panel lights up.
- 4 Display Window: Program remaining time, delay time, running indicator, temperature of water, fault codes and etc.
- 5 Program Button: Select different program according to the soiled level, such as Intensive, Normal and Rinse.
- 6 Delayed Start Button: Press this button to set the delayed hours for washing.
- 7 Temperature Button: Display the water temperature during the wash cycle by pressing the button.
- 8 Start / Pause Button: Press this button to start or stop the dishwasher, the light will come on when starting.
- 9 Door Handle: Pull it to open the door. The machine will stop when the door is opening.

▲ WARNING!

It is dangerous to open the door when washing, maybe burned by hot water.

SPECIFICATION OF DISPLAY



Washing Program: Intensive, Normal, Economic, Rinse, Glass, Rapid and Pre-rinse.



Information Display: You can get information from it such as washing program, Error, Door-Open and etc.



Washing Phase: the 1st sign is pre-rinse, the 2nd is main wash, the 3rd is rinse and the last one is drying, they will run and alternate when washing



State Information: the 1st sign means the display is remain time of washing, the 2nd sign means the delay start time, the 3rd means the display of temperature.



Digital Display: display the remaining time, error code and the delay start time.



Temperature Setpoint: Display the water setpoint in the main wash phase of a wash cycle.

TURNING ON THE APPLIANCE

Starting a wash cycle. . .

- 1 Draw out the lower and upper basket, load the dishes and push them back. It is commended that loading the lower basket first, then the upper one.
- 2 With a little force to ensure the door is properly closed.
NOTE: A click could be heard when the door is closed perfectly.
- 3 Insert the plug into the socket.
The power supply is 120VAC 60HZ, the specification of the socket is 10A 250VAC.
- 4 Press the POWER button
- 5 According to the soil level to choose the desired program by pressing(or turning around) the program selection button(or knob).
- 6 Press the Start/Pause button to start the washing.
- 7 When the washing is over, you can shut off the switch .

Change the Programme

When the dishwasher is running, you want to change the using programme, you should do according the following step.

- 1 Shut off the power, then turn on the power.
- 2 Turn around the programme knob to select the desired programme.
- 3 Press the Start button to start washing.



At the end of the wash

At end of washing, the time display will flash for 8 seconds while the buzzer sound. But at the end of delayed washing, no sound of the buzzer, only the flash of the time display.





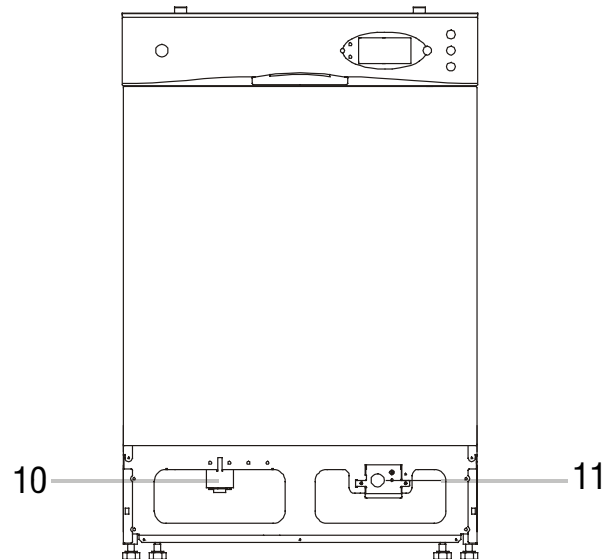
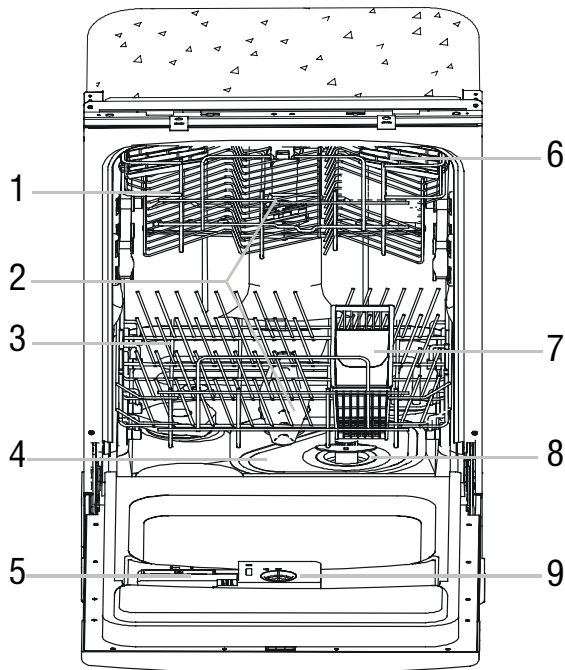

NOTE: If you open the door when washing, the machine will delay start for several seconds, which will make the dishwasher work much better.

Dishwasher Features



- | | | | |
|--------------|-----------------------|-----------------------|-----------------|
| 1 Upper Rack | 4 Main Filter | 7 Silverware Basket | 10 Inlet Valve |
| 2 Spray Arms | 5 Detergent Dispenser | 8 Coarse Filter | 11 Junction Box |
| 3 Lower Rack | 6 Cup Shelf | 9 Rinse Aid Dispenser | |

WASH CYCLE TABLE

Program	Cycle	Cycle Selection Information	Description of Cycle	Detergent pre/main	Rinse Aid
Intense		For the heaviest soiled loads, such as pots, pans, casserole dishes and dishes that have been sitting with dried food on them for a while.	Pre-rinse Pre-rinse(122°C) Wash (158°C) Rinse Rinse (150°C) Drying.	5/22 gr.	★
Normal		For normally soiled loads, such as pots, plates, glasses and lightly soiled pans. standard daily cycle.	Pre-rinse Pre-rinse Wash (140°C) Rinse Rinse (150°C) Drying.	5/22 gr.	★
Economy		For lightly soiled loads, such as plates, glasses, bowls and lightly soiled pans.	Pre-rinse Wash (122°C) Rinse Rinse (150°C) Drying.	22 gr.	★
Rinse		For dishes that need to be rinsed and dried only	Rinse Rinse (150°C) Drying.		★
Fast wash		A shorter wash for lightly soiled loads that do not need drying.	Pre-rinse Wash (104°C) Rinse Rinse (150°C) Drying.	15 gr.	★
Rapid		For lightly soiled loads, such as glasses, crystal and fine china.	Pre-rinse Wash (122°C) Rinse Rinse (140°C)	15 gr.	
Prerinse		Pre-wash of dishes pots and pans while waiting for the load to be completed after the subsequent meal.	Pre-rinse		

ERROR CODES

Codes	Meanings	Possible Causes
E1	Longer inlet time.	Faucets is not opened.
E2	Longer draining time.	The installation position of the drain pipe is too high.
E3	Longer heating time, but not reaching required temperature	Malfunction of temperature sensor or of heating element.
E4	Overfilled.	Too much inlet water. .
E6	Failure of temperature sensor	Open thermistor
E7	Failure of temperature sensor	Short thermistor

WARNING!

If overflow occurs, turn off the main water supply before calling a service. If there is water in the base pan because of an overflow or small leak, the water should be removed before restarting the dishwasher.

DETERGENT DISPENSER

YOU MAY NOT ADD TOO MUCH DETERGENT TO PREVENT THE FORMATION OF DEPOSITS BECAUSE YOUR DISHWASHERS HAVE SPECIALLY-DESIGNED WATER SOFTENERS.

The dispenser must be refilled before the start of each wash cycle following the instructions provided in the "Wash Cycle Table". Your dishwashers use less detergent and rinse aid than conventional dishwashers. Generally, only one tablespoon of detergent is needed for a normal wash load. Also, more heavily soiled items need more detergent. Always add the detergent just before starting dishwasher, otherwise it could get damp and will not dissolve properly.

Amount of Detergent to Use

IF THE WATER ISN'T TOO HARD, YOU MAY ALSO PREVENT THE FORMATION OF DEPOSITS BY ADDING DETERGENT. The amount of detergent needed can vary due to differences in water hardness. To determine the water hardness in your area, contact your local water utility or area water softening company. The harder the water, the more detergent you may need. Remember, you should adjust the amount of detergent you use by small amounts until you find the correct amount.

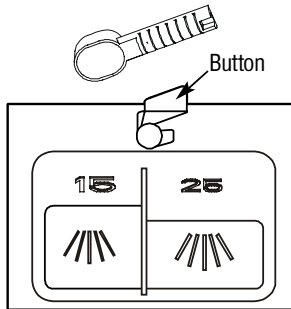

To open the wash cover, press the button and the cover will flip back.

⚠ WARNING!

Dishwasher detergent is corrosive! Take care to keep it out of reach of children.

Removing Hard Water Spots

To remove hard water spots, try the following:

- Run dishes through a normal wash program.
- Remove all metal dishware, such as cutlery, pans, etc., from the dishwasher.
- Do not add detergent.
- Pour two cups of vinegar into a bowl and set the bowl face up on the lower rack of the dishwasher.
- Run the dishwasher through a normal wash program.

If this doesn't work, try the same process with 1 / 4 cup of citric acid crystals instead of vinegar.

Proper Use of Detergent

Use only detergent specifically made for use in dishwashers. Keep your detergent fresh and dry. Don't put powder detergent into the dispenser until you're ready to wash dishes.

RINSE AID DISPENSER

Filling the Dispenser

The rinse agent dispenser holds 3.5 oz. of rinse agent. Under normal conditions, this will last approximately one month. Try to keep it full, but do not overfill.

- Make sure the dishwasher door is fully open.
- Turn the dispenser knob to the left and lift it out.
- Add rinse agent until the indicator window looks full.
- Clean up any spilled rinse agent with a damp cloth.
- Replace the dispenser knob.

Rinse Aid Setting

The amount of rinse agent released into the final wash can be adjusted. The factory setting is at the midpoint. If there are rings of calcium (hard water) spots on dishes, try a higher setting.

To adjust the setting

Remove the dispenser knob; then turn the adjuster counterclockwise to increase the amount of rinse agent.

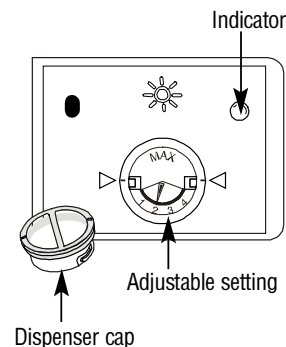

Loading the Dishwasher Racks

For best performance of the dishwasher, follow these loading guidelines. Features and appearance of racks and silverware baskets may vary from your model.

How to use the Upper Rack

The upper rack is designed to hold more delicate and lighter dishware such as glasses, coffee and tea cup and saucers, as well as plates, small bowls and shallow pans (as long as they are not too dirty).

Position the dishes and cookware so that they do not get moved by the spray of water.

The upper rack can be adjusted for height by putting wheels of different height into the rails.

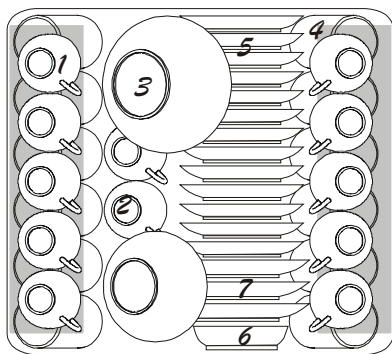

- 1 Cups
- 2 Small serving bowl
- 3 Large serving bowl
- 4 Glasses
- 5 Saucers
- 6 Dish
- 7 Plates

How to use the Lower Rack

We recommend that you place large items which are most difficult to clean into the lower rack: pots, pans, lids, serving dishes and bowls, as shown in the figure to the right.

It is preferable to place serving dishes and lids on the side of the racks in order to avoid blocking the rotation of the top spray arm.

- Pots, serving bowls, etc, must always be placed top down.
- Deep pots should be slanted to allow water to flow out.
- The bottom rack feature fold down tine rows so that larger or more pots and pans can be loaded.

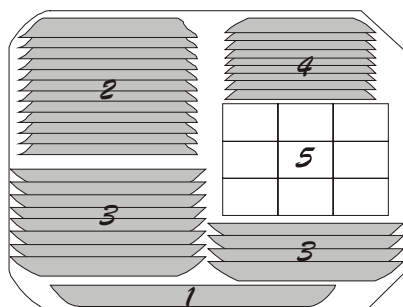

- 1 Oval platter
- 2 Dinner plates
- 3 Soup plates
- 4 Dessert dishes
- 5 Silverware basket

SILVERWARE BASKET

Silverware should be placed in the silverware basket with handles at the bottom: If the rack has side baskets, the spoon should be loaded individually into the appropriate slots, Especially long utensils should be placed in the horizontal position at the front of the upper rack.

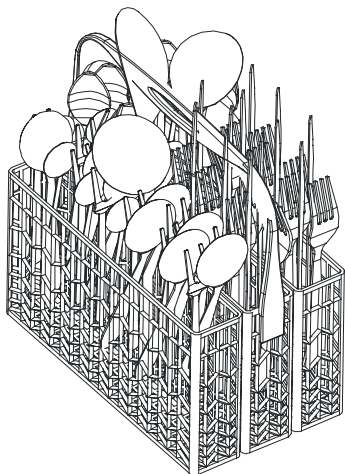

Forks	Knife
Soup spoons	Serving spoon
Dessert spoons	Gravy ladle
Teaspoons	Serving fork



▲ **WARNING!**

Do not let any item extend through bottom.

Filtering System

For your convenience, we have placed the drain pump and filtering system within easy reach inside the tub. There are three components of the filtering system: the main filter, the coarse filter, and the fine filter.

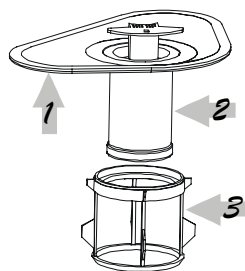

- 1** Main filter
Food and soil particles trapped by this filter are pulverized by a special jet on the lower spray arm and washed down the drain.
- 2** Coarse filter
Larger items, such as pieces of bone or glass, that could clog the drain are trapped in the coarse filter. To remove an item caught in this filter, gently squeeze the tabs on top of this filter and lift it out.
- 3** Fine filter
This filter holds soil and food residue in the sump area and prevents it from being redeposited on the dishes during a cycle.

Caring for the Dishwasher

To clean the control panel use a lightly dampened cloth then dry thoroughly. To clean the exterior use a good appliance polish wax.

Never use sharp objects, scouring pads or harsh cleaners on any part of the dishwasher.

Protect Against Freezing

If your dishwasher is left in an unheated place during the winter, ask a service technician to:

- 1** Cut off electrical power to the dishwasher. Remove fuses or trip circuit breaker.
- 2** Turn off the water supply and disconnect the water inlet pipe from the water valve.
- 3** Drain water from the inlet pipe and water valve. (Use a pan to catch the water.)
- 4** Reconnect the water inlet pipe to the water valve.
- 5** Remove the plastic sump cover in the tub the bottom and use a sponge to soak up water in rubber boot.

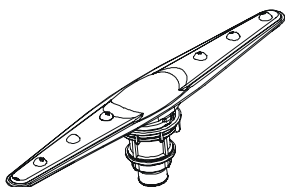

Cleaning the Spray Arms

It is necessary to clean the spray arms regularly for hard water chemicals will clog the spray arm jets and bearings. To remove the spray arm, screw off the nut to take out the washer on top of the spray arm and remove the arm. Wash the arms in soapy and warm water and use a soft brush to clean the jets. Replace them after rinsing them thoroughly.

User–Maintenance Instructions

Cleaning the Filters

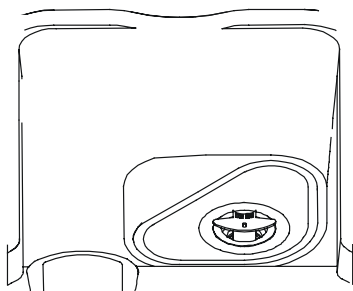

Filter assembly

For best performance and results, the filter assembly must be cleaned. The filter efficiently removes food particles from the wash water, allowing it to be recirculated during the cycle. For this reason, it is a good idea to remove the larger food particles trapped in the filter after each wash cycle by rinsing the semicircular filter and cup under running water. To remove the filter assembly, pull on the cup handle in the upward direction. The entire filter assembly should be cleaned at least once a month.

To clean the coarse filter and the fine filter, use a cleaning brush. Then, reassemble the filter parts as shown in the figures left and reinsert the entire assembly in the dishwasher, positioning in its seat and pressing downward.

The dishwasher must never be used without the filters. Improper replacement of the filter may reduce the performance level of the appliance and damage dishes and utensils.

▲ WARNING!

Never run the dishwasher without the filters in place.

Cleaning the Door

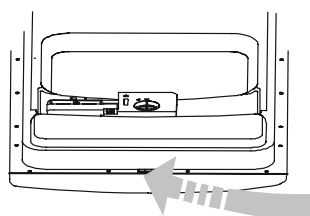

To clean the edge around the door, you should use only a soft warm, damp rag. To prevent penetration of water into the door lock and electrical components, do not use a spray cleaner of any kind.

Also, never use abrasive cleaners or scouring pads on the outer surfaces because they will scratch the finish. Some papers towels can also scratch or leave marks on the surface.

▲ WARNING!

Never use a spray cleaner to clean the door panel for it could damage the door lock and electrical components. It is not allowed to use the abrasive agent or some paper towel because of the risk of scratching or leaving spots on the stainless steel surface.

How to Keep Your Dishwasher in Shape

■ *After Every Wash*

After every wash, turn off the water supply to the appliance and leave the door slightly ajar so that moisture and odors are not trapped inside.

■ *Remove the Plug*

Before cleaning or performing maintenance, always remove the plug from the socket. Do not run risks.

■ *No Solvents or Abrasive Cleaning*

To clean the exterior and rubber parts of the dishwasher, do not use solvents or abrasive cleaning products.

Rather, use only a cloth and warm soapy water.

To remove spots or stains from the surface of the interior, use a cloth dampened with water and a little white vinegar, or a cleaning product made specifically for dishwashers.

■ *When You Go on Holiday*

When you go on holiday, it is recommended that you run a wash cycle with the dishwasher empty and then remove the plug from the socket, turn off the water supply and leave the door of the appliance slightly ajar. This will help the seals last longer and prevent odors from forming within the appliance.

■ *Moving the Appliance*

If the appliance must be moved, try to keep it in the vertical position. If absolutely necessary, it can be positioned on its back.

■ *Seals*

One of the factors that cause odors to form in the dishwasher is food that remains trapped in the seals. Periodic cleaning with a damp sponge will prevent this from occurring.

Before Calling for service . . .

Troubleshooting Tips

Review the charts on the following pages may make you be free of calling for service.



<i>Problem</i>	<i>Possible Causes</i>	<i>What To Do</i>
<i>Dishwasher doesn't run</i>	Fuse blown, or the circuit breaker acted	Replace fuse or reset circuit breaker. Remove any other appliances sharing the same circuit with the dishwasher
	Power supply is not turned on	Make sure the dishwasher is turned on and the door is closed securely. Make sure the power cord is properly plugged into the wall socket..
	Water pressure is low	Check that the water supply is connected properly and the water is turned on.
<i>Drain pump doesn't stop</i>	Overflow	The system is designed to detect an overflow. When it does, it shuts off the circulation pump and turns on the drain pump.
<i>Noise</i>	Some audible sounds are normal	Sound from soft food shredding action and detergent cup opening.
	Utensils are not secure in the baskets or something small has dropped into the basket	To ensure everything is secured in the dishwasher.
	Motor hums	Dishwasher has not been used regularly. If you do not use it often, remember to set it to fill and pump out every week, which will help keep the seal moist.
<i>Suds in the tub</i>	Improper detergent	Use only the special dishwasher detergent to avoid suds. If this occurs, open the dishwasher and let suds evaporate. Add 1 gallon of cold water to the tub. Close and latch the dishwasher, then drain out the water by slowly turning the Dial until a drain period is reached. Repeat if necessary.
	Spilled rinse agent	Always wipe up rinse agent spills immediately.
<i>Stained tub interior</i>	Detergent with colorant was used	Make sure that the detergent is the one without colorant.
<i>Dishes are not dried</i>	Rinse agent dispenser is empty	Make sure that the rinse agent dispense is filled.
<i>Dishes and flatware not clean</i>	Improper program	Select stronger program
	Improper rack loading	Make sure that the action of the detergent dispenser and spray arms are not blocked by large dishware.
<i>Spots and filming on glasses and flatware</i>	<ul style="list-style-type: none"> 1 Extremely hard water 2 Low inlet water temperature 3 Overloading the dishwasher 4 Improper loading 5 Old or damp powder detergent 6 Empty rinse agent dispenser 7 Incorrect dosage of detergent 	<ul style="list-style-type: none"> • To remove spots from glassware: <ul style="list-style-type: none"> 1 Take out all metal utensils out of the dishwasher. 2 Do not add detergent. 3 Choose the longest cycle. 4 Start the dishwasher and allow it to run for about 18 to 22 minutes, then it will be in the main wash. 5 Open the door to pour 2 cups of white vinegar into the bottom of the dishwasher. 6 Close the door and let the dishwasher complete the cycle. If the vinegar does not work: Repeat as above, except use 1/4 cup (60 ml) of citric acid crystals instead of vinegar.

Before Calling for service . . .

<i>Problem</i>	<i>Possible Causes</i>	<i>What To Do</i>
<i>Cloudiness on glassware</i>	Combination of soft water and too much detergent	Use less detergent if you have soft water and select a shortest cycle to wash the glassware and to get them clean.
<i>Yellow or brown film on inside surfaces</i>	Tea or coffee stains	Using a solution of 1/2 cup of bleach and 3 cups warm water to remove the stains by hand. ⚠ WARNING You have to wait for 20 minutes after a cycle to let the heating elements cool down before cleaning interior; otherwise, burns will happen.
	Iron deposits in water can cause an overall film	You have to call a water softener company for a special filter.
<i>White film on inside surface</i>	Hard water minerals	To clean the interior, use a damp sponge with dishwasher detergent and wear rubber gloves. Never use any other cleaner than dishwasher detergent for the risk of foaming or suds.
<i>Detergent cup lid won't latch</i>	Dial is not in the OFF position	Turn the Dial to OFF position and slide the door latch to the left.
<i>Detergent left in dispenser cups</i>	Dishes block detergent cups	Re-loading the dishes properly.
<i>Steam</i>	Normal phenomenon	There is some steam coming through the vent by the door latch during drying and water draining.
<i>Black or gray marks on dishes</i>	Aluminum utensils have rubbed against dishes	Use a mild abrasive cleaner to eliminate those marks.
<i>Water standing in the bottom of the tub</i>	This is normal	A small amount of clean water around the outlet on the tub bottom at the back of the tub keeps the water seal lubricated.
<i>Dishwasher leaks</i>	Overfill dispenser or rinse aid spills	Be careful not to overfill the rinse aid dispenser. Spilled rinse aid could cause oversudsing and lead to overflowing. Wipe away any spills with a damp cloth.
	Dishwasher isn't level	Make sure the dishwasher is level.

EQUATOR CONTACT NUMBER

PARTS & SERVICE: (800) 776-3538



Equator Corporation
Equator Plaza
2801 W. Sam Houston Parkway N.
Houston, Texas 77043-1611
Tel: 713-464-3422 Fax: 713-464-2151
Toll Free: 800-935-1955
All Rights Reserved
Manual subject to change without notice