



Washer-Dryer

Owner's Manual

GB

Lavadora y Secadora por condensación

Instrucciones para la instalación y el uso

Es

THE COMPLETE LAUNDRY SYSTEM !

¡EL SISTEMA COMPLETO DE LAVADO Y SECADO!



Quick guide

Here are the 11 topics explained in this manual. Read, learn and have fun. You will discover many secret ways to get a better wash more easily, and making your washer-dryer last longer.

1. Warranty Information (page 2)

Here are the warranty clauses that give you specific legal rights, for normal, personal, family or household use in the USA and Canada.

2. Introduction (pages 3-4-5)

The top ten reasons for buying your washer-dryer. Also covered:

1. Important Safety Instructions for you and your family. Read this section carefully.
2. Helpful Hints on using your new Washer-Dryer
3. Improving Dryer Efficiency
4. Pre-Installation

3. Installation (pages 6-7-8)

Installation, after delivery or transport, is the most important operation for the correct functioning of your washing machine.

Always check:

1. That the electric system conforms to regulations;
2. That the inlet and drain hoses are connected correctly. **Never use hoses that have already been used.**
3. That the washing machine is levelled properly - improving the performance of your washing machine.
4. **THAT THE DRUM'S SHIPPING BOLTS HAVE BEEN REMOVED FROM THE BACK OF THE WASHER-DRYER.**

4. What goes in your washing machine and how to start it (pages 8-9)

A correct distribution of your laundry is vital to the successful outcome of the wash and the life of the washer-dryer. Learn all the tips and secrets to dividing your linen: color, type of fabric.

5. Understanding the control panel (page 10)

This Washer-dryer's control panel is very simple. It has only a few essential buttons to help you choose any type of wash and dry cycle, ranging from the most energetic, capable of cleaning a mechanic's overalls, to the most delicate for wool. Familiarizing yourself with it will help you get the best out of your wash while helping your machine last longer.

6. Guide to the wash programs (page 11)

Here is an easy table to help you choose the right program, temperature, detergents and possible additives. Choose the right program and you will get better results with your wash while saving time, water and energy, day after day.



7. Useful tips to wash, dry and ... to avoid mistakes (pages 12-13-14)

Years back, our grandmothers were the ones who gave us good advice - and in those days synthetic fibers did not exist: washing was easy. Today, your washer-dryer offers you helpful advice allowing you even to wash wool better than an expert laundress would by hand.

8. The detergent dispenser (page 15)

How to use the detergent dispenser and the bleach compartment.

9. Problems and solutions (pages 16-17)

Before calling a technician, read these pages. Immediate solutions can be found for a many problems. If the problem persists, call Equator Customer Service. They will be glad to help.

10. Care and maintenance (page 17-18)

With just a bit of care, the washer-dryer will repay you with outstanding performance for years and years to come.

11. Technical characteristics (page 19)

Here are the technical features of your washer-dryer: model number, electric and water specifications, size, capacity, speed of the spin cycle and compliance with US & Canadian regulations.

Warranty Information

Your Equator[®] appliance is protected by this warranty under normal, personal, family or household use (1 Year), and limited commercial use (90 days) in the USA and Canada.

WARRANTY

Equator Corporation undertakes to the consumer-owner to repair or, at Equator Corporation's option, to replace any part of this product which proves to be defective in workmanship or material under normal personal, family or household use, in the USA and Canada, for a period of one year from the date of original purchase.

For commercial use, the product is warranted for a period of 90 days.

During this period, Equator Corporation will provide all labor and parts necessary to correct such defect, free of charge, if the appliance has been installed and operated in accordance with Equator Corporation's written instructions with the appliance. Ready access to the appliance, for service, is the responsibility of the consumer-owner.

EXCLUSIONS

In no event shall Equator Corporation be liable for incidental or consequential damages or for damages resulting from external causes such as abuse, misuse, incorrect voltage or acts God.

This warranty does not cover service calls which do not involve defective workmanship or materials covered by this warranty. Accordingly, diagnosis and repair costs for a service call which does not involve defective workmanship or materials will be the responsibility of the consumer-owner.

Specifically, the following work is not covered under warranty and does not constitute warranty work:

- Installation - improper hook-up or leveling
- Maintenance - cleaning of air and/or water filter
- Damage - replacing broken door handle

Most work is covered. The defining factor is, has the machine malfunctioned (Equator is responsible) or has the customer omitted or done something to cause machine to malfunction (customer is responsible).

Some States do not allow the exclusion or limitation of incidental or consequential damages, so the above limitation or exclusion may not apply to you.

WARRANTY SERVICE

This warranty is given by:

Equator Corporation,
Equator Plaza,
2801 W. Sam Houston Parkway N.
Houston, TX 77043

Service under this warranty must be obtained by the following steps, in order:

Call an Equator Corporation Authorized Service Agent (obtain number of nearest agent from your dealer or by calling Equator Service at 1-800-776-3538). Under normal circumstances, Service will be provided during regular business hours (9:00 a.m. to 5:00 p.m. weekdays).

GENERAL

Since it is responsibility of the consumer-owner to establish the warranty period by verifying the original purchase date, Equator Corporation recommends that a receipt, delivery slip or some other appropriate payment record be kept for that purpose.

Remember to send in your Warranty Registration Card so that a proof of your purchase exists with Equator.

This warranty gives you specific legal rights, and you may also have other rights which vary from State to State.

Corporate Office

EQUATOR CORPORATION
Equator Plaza
2801 W. Sam Houston Parkway N.
Houston, Texas 77043
Tel: 713-464-3422 - Fax: 713-464-2151
Toll Free: 800-935-1955

LISTED

 **Underwriters Laboratories Inc.®**
US N° 77119 CANADA

Introduction

Congratulations on your new Equator Washer-Dryer. In addition to its award winning design, this is a highly sophisticated engineered product that will give you many years of satisfaction. Please spend a few moments to read the Owners Manual. This will show you ways to best utilize your valuable purchase.

Here are 10 of the best reasons for buying your Washer-Dryer -

1. Maximum Energy Savings

This appliance is engineered to provide valuable energy savings when compared to other washer-dryers.

2. Maintenance Free

This appliance needs no cleaning of lint after drying.

3. Water Savings

This appliance uses between 9 gallons of water per wash cycle and 3 gallons per dry cycle (in 120 minutes of drying) saving almost 40 gallons over a standard full-size top-loading washer.

4. Improved Operation

With a spin speed of 1200 RPM, more water is extracted, allowing improved dry times.

5. Convenience

This appliance can be permanently installed and be made portable with casters and the faucet adapter kit (sold separately as accessories) where needed.

6. Combined Washing & Drying

No need for two separate machines for two tasks and no more transferring clothes from one to the other. Program the Washer Dryer and you have a two-in-one.

7. Better Clothing Appearance

This Washer-Dryer has no agitator to damage your clothes so they look better and last longer.

8. Placement Options

The Washer-Dryer's sleek Italian design makes it a perfect appliance for any Kitchen or Laundry Room. Its compact size makes the Washer-Dryer a perfect for placement on each floor of your home.

9. Easy Operation

This appliance is simple to use as a washer or as a dryer – or it can go seamlessly from wash to the dry functions.

10. Space Savings

The Washer-Dryer is designed to utilize horizontal and vertical space effectively.

Important Safety Instructions

Your safety and that of your children

Your washing machine has been built in compliance with the strictest international safety regulations, to protect you and all your family.

WARNING -To reduce the risk of fire, electrical shock, or injury to persons when using your appliance, follow basic precautions, including the following:

1. Read all instructions before using the appliance.
2. Do not wash or dry articles that have been previously cleaned in, washed in, or spotted with gasoline, dry cleaning solvents, other flammable or explosive substances as they emit vapors that could ignite or explode.
3. Do not allow children to play on or in the appliance. Close supervision of children is necessary when the appliance is used near children.
4. Before the appliance is removed from service or discarded, remove the door.
5. Do not reach into the appliance if the tub or drum is moving.
6. Do not install or store this appliance where it will be exposed to the weather.
7. Do not tamper with controls.
8. Do not repair or replace any part of the appliance or attempt any servicing unless specifically recommended in the user-

maintenance instructions or in published user-repair instructions that you understand and have the skills to carry out.

9. Do not add gasoline, dry-cleaning solvents, or other flammable or explosive substances to the wash water. These substances give off vapors, that could ignite or explode.

10. Under certain conditions, Hydrogen gas may be produced in a hot water system that has not been used for 2 weeks or more. **HYDROGEN GAS IS EXPLOSIVE.** If the hot water system has not been used for such a period, before using a washing machine or combination washer washer-dryer, turn on all hot after faucets and let the water flow from each for several minutes. This will release any accumulated Hydrogen.

11. Do not use fabric softeners or products to reduce static unless recommended by the manufacturers of the fabric softener product.

12. Do not use heat to dry articles containing foam rubber or similar textured rubber-like materials.

13. Check the Coin Trap every few months to remove any coins, buttons or similar size objects.

14. For vented washer-dryers keep the exhaust opening and surrounding areas free from accumulation of lint, dust, and dirt.

15. Do not place items exposed to cooking oil in your dryer. Items contaminated with cooking oils may contribute to a chemical reaction that could cause a load to catch fire.

Save these instructions

Safety



CAUTION:

To reduce the risk of electric shock, **DO NOT remove cover (or back)/no user servicable parts inside. Refer for servicing to qualified services personnel.**

The model number of this product may be found on the back of the unit; the serial number of the label affixed to the back of the unit.

You should note the model and serial numbers of this unit in the space provided. Retain this booklet as a permanent record of your purchase to aid in identification in the event of theft.

MODEL N. _____
SERIAL N. _____

WARNING:

TO PREVENT FIRE OR SHOCK HAZARD DO NOT EXPOSE THIS PRODUCT TO RAIN OR MOISTURE.



The **lightning flash** with arrowhead symbol, within an equilateral triangle, is intended to alert the user to the presence of uninsulated “dangerous voltage” within the product’s enclosure that may be of sufficient magnitude to constitute a risk of electric shock to persons.



The **exclamation point** within an equilateral triangle is intended to alert the user to the presence of important operating and maintenance (servicing) instructions in the literature accompanying the appliance.



Money Isn't All You're Saving

Equator Appliances is proud to offer our customers products with the ENERGY STAR label.

Helpful Hints

Your Washer Dryer features three different speeds during the wash cycle. During the Cotton cycle the drum spins at 1,200 or 800 rpm depending on how you set it. During Permanent Press the drum spins at 850 rpm. During delicates, the drum spins at 500 rpm. When drying heavy cotton articles such as bath towels or jeans, be sure the “Regular” washer setting is selected. The faster spinning will extract more water from these highly absorbent fabrics and reduce the degree of dampness as the machine goes into the drying mode. This will cut down on your drying time.

Use Liquid Fabric Softener. Fill the softener compartment up to the level marked. Using fabric softener fluffs out clothes immediately after the wash cycle. This helps speed drying time and reduce wrinkles.

This Washer Dryer is a 110 Volt machine, so the heating element requires more time to achieve full heat than a larger 220 volt unit requires. The heating element will take about 10 minutes to reach full heat.

To dry your laundry, the Washer Dryer blows heated air into the rotating drum. As the drum tumbles your laundry, the warm air dries it. If the drum is overfilled with laundry, the air is not allowed to circulate and clothes will not dry properly.

Use Low sudsing Detergent. This is recommended for all front loading washers. It ensures there is no over sudsing, which may reduce the performance of your machine. Also, this prevents damage to your machine which may be caused by excess suds entering the condensing chamber and clogging the fan blower mechanism with lint. If you have any problem obtaining low sudsing detergent, please call Equator to obtain information on our house brand, Equator low sudsing detergent. A coupon for a free box of the Equator detergent is enclosed with the warranty card.

When sorting laundry always take into consideration the quantity and type of fabric contained in the load. Highly absorbent fabrics such as those used in towels or jeans will absorb more water and become very heavy when saturated. If you notice that your clothes are taking longer than usual to dry you may be overloading the machine, or washing too many highly absorbent articles for a single load.

Dryer Efficiency

Your washer dryer operates on 110 volts and has a 1,300 watt dryer. It will take a longer time to dry clothes than a traditional dryer (which operates on 220 volts, 5,000 watts). However, with the following tips, you can increase the efficiency of the dryer.

1. DOOR REMAINS LOCKED DURING DRYING: The door is electronically kept locked during drying cycle, with the Mode+Door Lock light on. This prevents any starting and shutting the heater, which in turn conserves energy by trapping the heat.

2. FABRIC SOFTENER: When the Wash and Dry cycles are set to run consecutively, the preheat function comes on automatically. In this, the heater is turned on during the last spin cycle of the wash program. In the Regular Wash program, the clothes will be getting spun at 1,200 rpm, while hot air from the dryer will be entering the drum at the same time. While centrifugal force causes clothes to stick to the sides of the drum, the hot air will “bake” them to the sides. It may take 30 minutes or more for the clothes to unstick and fall into the drum. **USING LIQUID FABRIC SOFTENER WILL CAUSE THE CLOTHES TO UNSTICK IMMEDIATELY. THIS HELPS DRY CLOTHES FASTER AND CAUSES LESS WRINKLES.**

3. OVERLOADING: The drum has a capacity of 1.92 cu. ft. While this is the largest drum available on any combination washer-dryer, it is smaller than a standard U.S. washer. The EZ 3612 CEE drum should not be overloaded. With too many clothes, airflow is reduced, increasing drying time. A maximum of 2/3 of the drum full of clothes is recommended for ideal drying.

4. OVER DRYING: This machine uses a condensing dryer. In this cold water is used to condense the moisture from the hot air. Since there is no external exhaust system, the moisture remains in the machine. Frequently, when it seems the clothes are damp, it is actually the remaining moisture (like dew). Take clothes out and within a few minutes they will be dry. Do not overdry the clothes.

5. USE LOW SUDSING DETERGENT: By using low sudsing detergent (Equator brand or any other), you are preventing suds from entering the condensing chamber. When suds enter the condensing chamber, lint particles can clog up the chamber and the fan blower. Over time, this reduces drying efficiency and may require the fan blower (impeller) to be cleaned.

Your new appliance is a carefully engineered product. Many times what appears to be a reason to call for service, requires nothing more than a simple adjustment you can easily make in your own home.

You will be charged for a service call while the appliance is in warranty if the problem is not caused by defective product workmanship or materials covered by this warranty.

To avoid a charge for an unnecessary service call, and before calling a serviceman, please refer to the troubleshooting section for situations that you can remedy. This section is included on pages 16-17 of this Use and Care Book.

Your Washer-Dryer is front loading, with an extra large door opening for easier access. **It has 9 wash cycles** in addition to *extra rinse* and *pre wash* cycles.

You will obviously want to obtain the best possible wash. By reading and following the instructions in this booklet you will achieve excellent results.

Please, ensure that the instructions are followed. If you should need any further advice or assistance, please, contact the dealer where your machine was purchased, or call Equator Customer Service at 1-800-776-3538.

This appliance is an automatic washer with a capacity of up to:
1.92 cu. feet

PRE-INSTALLATION

1. The washer must be installed on a strong level floor, and in protected, dry, and well-ventilated area close to a power and water supply of sufficient capacity, and a sufficient outlet.

2. Installation on Carpet or Wood increases vibrations.

- Carpets - place on light carpet only.
- Wood - brace floor with screws and place additional sheets of plywood before installation.

3. Dryer installation and grounding should be done in accordance with local codes by a qualified installer. “Installation Instructions” are included in your Use and Care manual for the Installer’s reference.

4. The washer should be plugged into a properly grounded three (3) prong electrical outlet of 120 Volt, 1300 W, 13 A, 60 Hz. It should not be controlled by a wall switch or pull cord which might be turned off accidentally.

Installation

When the new washer-dryer arrives

Whether new or just transported to a new house, installation is extremely important for the correct functioning of your washer-dryer.

After removing the appliance from its packaging, check that it is intact. If in doubt, contact Equator immediately. **The inside of the machine is supported, for transportation, by four shipping bolts on the back panel.**

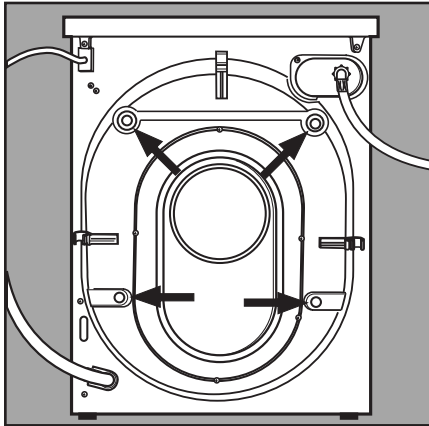

Before using the washer-dryer, remove the external shipping bolts, remove the spacers together with the rubber tubes attached to them (save all the parts) and use the plastic blanking plugs provided to fill in the holes. Use the wrench provided to remove the external bolts.

Attach the two rubber hoses provided to the red (hot) and white (cold) water inlets on the back (top right) of the appliance. Connect the other ends to the appropriate built-in water supplies or a Y-adapter / Faucet Adapter combination to a single source (like a kitchen faucet.). Using the "U"-Connector provided, place the drain hose into the drain pipe (or the sink.) See Plumbing on Page 7 for more details.

Leveling

The washer-dryer must be levelled appropriately in order to guarantee its correct functioning. To level the appliance, the front feet must be adjusted; the angle of inclination, measured according to the worktop, must not exceed 2°.

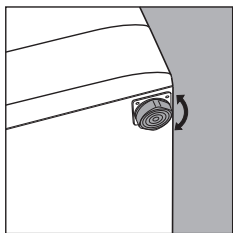

The front feet are self-locking & adjustable

WARNING **Electrical Requirements**

Electrical Shock Hazard (death, fire or electrical shock):

- 1) Plug into a grounded 3 prong outlet.
- 2) Do not remove ground prong.
- 3) Do not use an adapter or an extension cord.

Retain the shipping bolts, spacers and washers. Should you move residence then these should be replaced to support the inside of the machine to prevent damage when transporting the machine.

For your own protection, and to prevent accidents, injury and fire, please read the following carefully:

1. Destroy the carton and plastic bags, after the washer-dryer has been unpacked.
2. Children should never be left alone or unattended in the area where appliances are located.
3. Washer installation and grounding must be done in accordance with local codes by a qualified installer. Installation instructions are packed in new washer to the installer's reference.
4. ONLY the Equator Low Sudsing detergent is recommended for this appliance. To order your box of Equator detergent call **1-800-935-1955**.
5. The washer must be plugged into a properly grounded 3-prong electrical outlet. For your safety, the third or round grounding prong must never be removed.
DO NOT USE AN EXTENSION CORD.
6. Repair or replacement of a part should be made only by a qualified service technician to prevent personal injury or damage to the machine. For a list of authorized repair service agents, call **Equator Service at 1-800-776-3538**.

7. Disconnect power to the washer at the circuit breaker or fuse box, or unplug the machine in an emergency when servicing is required. Have the installer show you and label the proper switch or fuse at the electrical disconnect box.

WARNING - The Appliance should be connected to an Individual Branch Circuit with N. 14 AWG Wire and Protected by 15 A Fuse.

GROUNDING INSTRUCTIONS

This appliance must be grounded. In the event of malfunction, or breakdown, grounding will reduce the risk of electric shock by providing a path of least resistance for electric current. This appliance is equipped with a cord having an equipment-grounding conductor and grounding plug. The plug must be plugged into an appropriate outlet that is properly installed and grounded in accordance with all local codes and ordinances.

WARNING - Improper connection of the equipment-grounding conductor can result in a risk of electric shock. Check a qualified electrician if you are in doubt as to whether the appliance is properly grounded.

Do not modify the plug provided with the appliance. If it will not fit the outlet, have a proper outlet installed by a qualified electrician.

Warning !

The company denies all liability if and when these instructions are not respected. Plastic bags, expanded styrofoam, nails and other packaging parts are not children's toys, are potentially dangerous and should be disposed off properly.

PLUMBING (Water Inlet)

Included in the accessories supplied with this machine are 2 inlet hoses and 4 rubber washers. The straight end of these hoses should be connected to the supply fig. 1.

The 90° angled end of these hoses should be connected to the inlet valves on the back of the machine, using one of the washers to make a water tight seal on each connection. The couplings should be tightened by hand, a tool should only be used if a leak occurs. Do not use excessive force (see M, fig. 1).

The inlet valves are color coded:

Red = Hot
White = Cold

It is possible to run the machine on a single faucet with cold water only, but water must be supplied to each inlet valve. The "Y" connector allows a single water source to be split into the two inlets at the rear of the appliance (see fig. 2). The "Y" connector is part of the faucet available kit - available as an accessory from Equator Parts 1-888-483-9627.

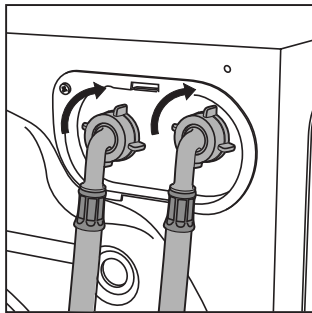

Fig. 1 - Water pipe inlet at the top right

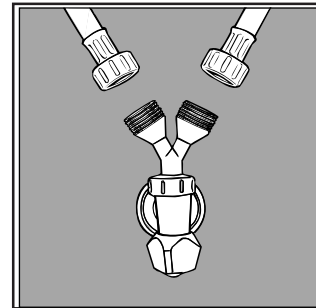

Fig. 2 - The "Y" Connector for single faucet connection

Connection to the water mains

Water pressure must range within the values indicated on the data plate on the rear of your washer-dryer. If the water pipes are new or left unused, then before connecting the machine run the water until clear to remove debris. Connect the inlet hose to a cold water tap having a 3/4" BSP thread. Ensure that there are rubber washers at each end of the inlet hose. The L-Shaped end goes on the machine and straight ends on the water faucets

Note: Replace inlet hoses after 5 years of use to reduce the risk of hose failure. Record hose installation or replacement dates on the hoses for future reference.

Periodically inspect and replace hoses if bulges, kinks, cuts, wear or leaks are found.

PLUMBING (Water Out)

You should carefully position the drain hose to avoid kinks and ensure proper drainage of the water.

The outlet end of the drain hose must be at least 25" (62 cm) above the base of the machine. At this point it is possible for the water to be discharged into a sink or drain pipe, but an air break must be available at this 24" height to prevent the machine from syphoning (see fig. aside).

No more than 6" of the drain hose should be inserted in the drain pipe.

IMPORTANT

make sure that the drain hose is not kinked and the water flow has not been restricted.

Standpipe drain system:

In RV installation needs a 1-1/2 inch (3.7 cm) diam. standpipe with minimum carry away capacity of 7 gallons (31 liters) per minute or 2" (5 cm) in home installation.

Floor Standpipe drain:

Top of standpipe must be at least 25 inches (62 cm) high and no higher than 34 inches (86 cm) from the bottom of washer (A).

Wall standpipe drain:

25 inches (62 cm) min.; 34 inches (86 cm.) max from end of drain hose to bottom of washer (B).

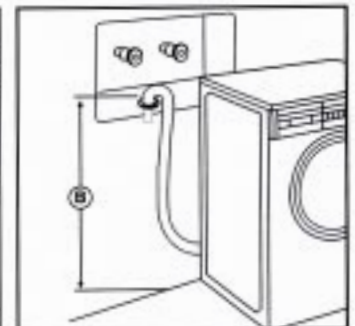
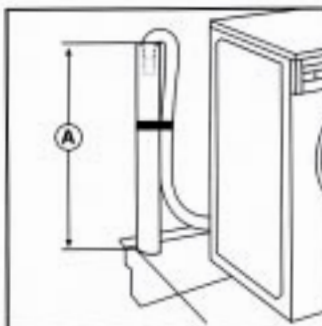
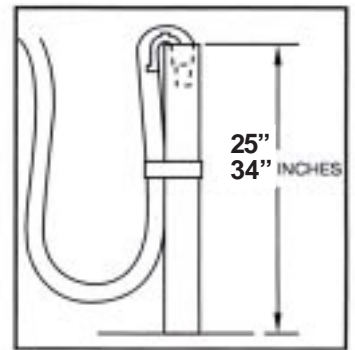
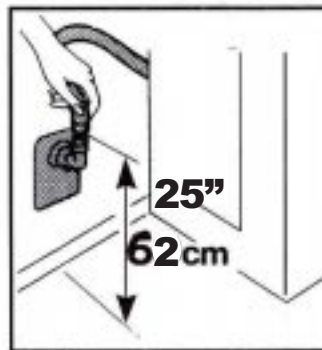

RECESSED, CLOSET AND ALCOVE INSTALLATION (Instructions)

The machine may be installed in a recessed area, closet or alcove.

The installation spacing is in inches and is the minimum acceptable.

Additional spacing should be considered for easy installation, servicing and in compliance with local codes or ordinances.

Other installation must use the minimum dimensions indicated.

* Additional clearances for wall, door and floor moldings may be required.

Minimum installation spacing *

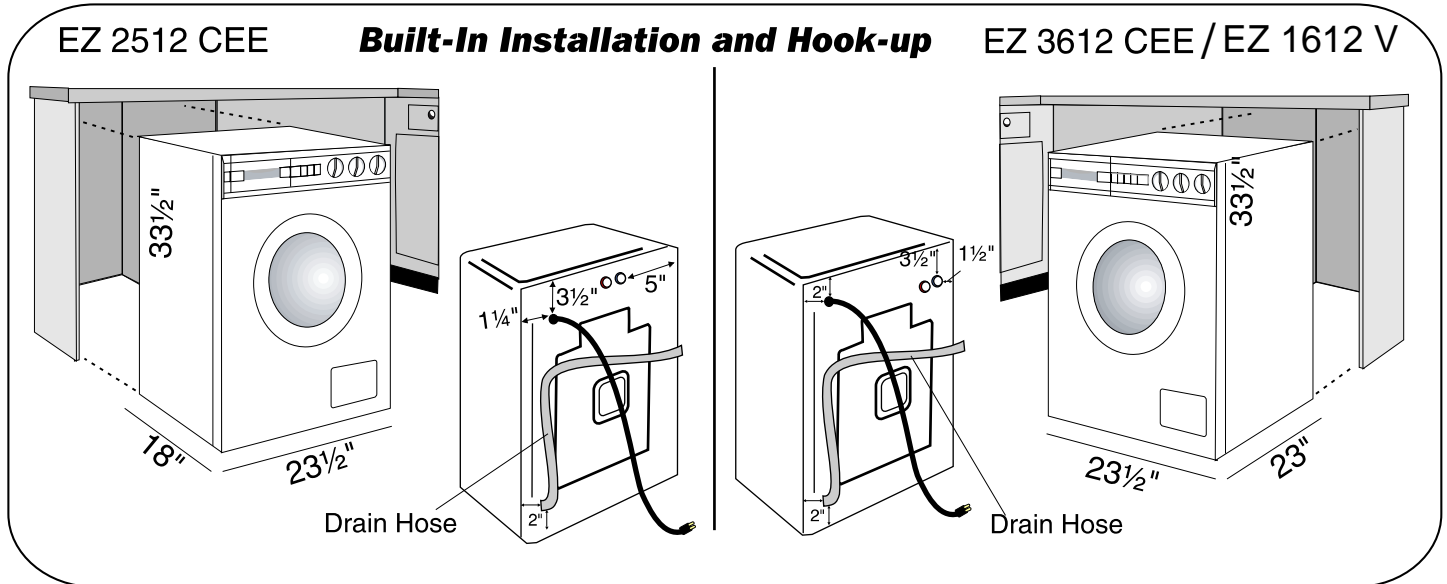

Operating instructions

What goes in your washer-dryer ?

Before washing, you can do a great deal to ensure better results. Divide your garments according to fabric and color. Read the labels, follow their guidelines.

Dividing your garments according to fabric and color, is very important for good results

LAUNDRY PREPARATION

Sorting

Clothes should be sorted from separate items which could damage other garments. Sort items into loads according to similar colors, fabrics, garment construction and degrees of soil.

- **Color.** Separate clothes into three groups: whites and pastels, medium and bright colors and dark colors. Items which bleed color should be washed alone.

- **Type of fabrics.** Delicate items should be separated from sturdier items. Fabrics that shed lint should be separated from those which shed none or attract lint.

- **Garment constructions.** Garments that may fray easily or that have unusual trim require gentle care. These garments may be washed in the loader using the knit cycle. If garments are fragile and delicate, hand washing may be desirable.

- **Degree of soil.** Heavily soiled items should be separated from the rest of the wash to prevent transfer of soil in the wash water.

Inspection

While sorting clothes into wash-loads, also inspect each garment to see if it requires special care.

- **Remove stains,** while they are fresh and easy to get out. Try cold water first to remove unknown stains. Hot water sets stains containing protein such as blood, egg, meat and milk. To remove difficult stains, refer to the removal Chart at the end of the manual.

- **Pretreat heavily soiled areas** such as collars, cuffs and centers of pillowcases. Refer to the "Pretreating" section for specific instructions.

- **Mend rips and tears,** before washing, so further damage is not done to garments.

- **Empty pockets.** Objects left in pockets such as crayon, pens or markers, or tobacco crumbs may stain an entire wash load. Paper tissues will shred leaving bits on each item in the washer. Remove coins and other foreign objects to prevent damage to the machine.

- **Fasten all hooks, zippers and buttons.**

- **Turn knit garments wrong side** out to reduce the tendency of knits to "pill". Fabric "pills" are balls of fibers on the surface **the garments caused by wear or friction.**

- **Remove loose dirt and sand.** Brush dirt from trouser cuffs; shake or vacuum rugs to remove loose surface soil.

- **If buckle is washable,** place a scrap of material securely around the ornament before washing and drying to prevent scratching and damage to the machine. Remove non-washable trims, buckles, buttons and belts.

- **Tie strings,** belts and apron sashes into bows to avoid tangling during washing.

- **Before loading the washer,** make sure the drum is empty.

Pretreating

Pretreat heavily soiled areas such as collars, cuffs and center of pillowcases by using a prewash spray, or brushing liquid detergent or a laundry detergent or a laundry detergent and water paste over the areas before washing.

Refer to the Stain Removal Chart for treatment of specific stains. If an entire item is heavily soiled or very stained, it may be both easier and more effective to prewash the item before laundering than to pretreat every spot.

Prewashing

Prewash excessively soiled clothes, such as work or children's clothes. They often get very soiled. Prewashing with detergent will help loosen the soil.

Laundry aids

Detergents are the most popular cleaning agents for home laundry.

Using too little detergent results in poor wash quality, while using too much causes excessive suds and poor rinsing. Detergents not only remove soil, but also hold it in suspension in the wash water to prevent redepositing it on the wash load. The amount to use depends on wash load size, amount of soil, water hardness and detergent type.

ALWAYS measure the amount of detergent. The amount of suds formed is not necessarily an indication of how much to use. Some detergents form a great amount of suds, others only a few. Use only detergents suitable for front loading washers.

LAUNDRY AIDS

1. Use only low sudsing detergent.
2. The degree of soil will change detergent amounts. For heavier soiled loads, increase the amount of detergent used.
3. If water is extremely hard, detergent should be increased. Less detergent should be used in soft water.
4. If garments have been pretreated, decrease the amount of detergent. If garments have been heavily pretreated, it may not be necessary to add detergent.
5. If the previous machine owned was a top loader, the initial washloads in a front loader may require a reduced quantity of

detergent until the detergent remaining in the clothes is removed. Old detergent trapped in the garments will be released during the tumble action wash cycle.

For quantities of detergent to be used, refer to the detergent manufacturer's instructions on the box.

Detergent will be flushed automatically into the machine from the detergent dispenser. The suds level should never rise more than halfway up to the porthole. Too much foam will not impede the wash action of your machine but will rise through the detergent dispenser and make a mess on the floor!

If this should happen clear excessive suds by setting the timer to the beginning of the first rinse and allow the machine to rinse out.

Bleaches

Bleach functions to whiten clothes, remove certain problem stains, to deodorize and in some cases to sanitize; however bleaching is not a substitute for good laundry techniques. Bleach should never be added to the rinse water. Always dilute bleach before using.

To add bleach, open detergent dispenser door and pour in **compartment 4** (see page 15 and 13-14).

WARNING:

Under no circumstances overfill the bleach dispenser. Excessive bleach will run directly into the machine and may possibly damage the clothes.

Fabric Softener

All fabrics, particularly towels, benefit from the use of fabric conditioners in the final rinse. Items of laundry feel softer, are more easily ironed and the clinging affect of synthetics is considerably reduced.

Pour the softener into "Additives" compartment of the detergent dispenser to the level indicated on the syphon. Under no circumstances overfill, as the softener will immediately syphon into the machine and in so doing, impair the wash results.

Starting the washer-dryer

After installing your new washer-dryer, start a wash cycle by setting a desired program .

Starting your washer-dryer in the right way is important for the quality of your wash, to help prevent future problems and enhance life expectancy of your appliance. Once you have loaded your washer-dryer and added the detergent together with any fabric conditioner,

always check that:

1. **The door is closed correctly.**
2. The plug is secured in the socket.
3. The water supply is turned on.

Choose the desired program

The program is selected according to the type of garments that need to be washed. To choose a program, refer to the table on page 11, then:

- 1) turn **Washer** knob until the selected program is aligned with the mark on the knob,

- 2) turn **Dryer** knob to the desired position,
- 3) Set the **Wash Temp** knob to the appropriate Wash/Rinse temperature settings,
- 4) if necessary use buttons **E, F, G, H** and lastly, press the Power button.
- 5) Remember that, if you want to use it, the **"programmed start"** should be set before the wash cycle.

At the end of the wash cycle...

Mode+Door Lock light will flash fast for a few seconds,

and then flashes slowly. Then turn the washer-dryer off by pressing **Power** button (**O** position). You can now open the washer-dryer door safely. After having removed the freshly cleaned laundry, leave the door open to allow air circulation inside the drum.

Remember that, in the event of a power failure, or should the washer-dryer switch itself off, the program chosen will remain in memory.

For more delicate garments: protect underwear, tights and stockings and delicate items by placing them in a canvas pouch

Making the right choice is important. And it's easy.

Here I'm in control

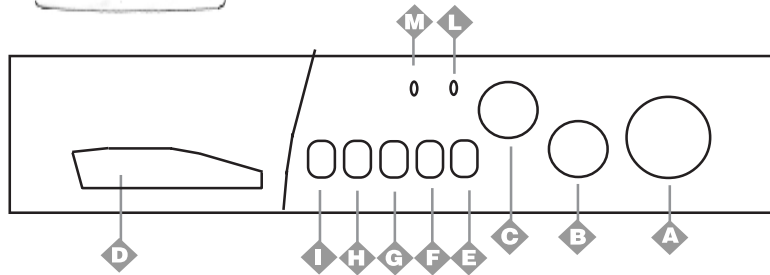

A Washer knob and Delay start

Use this knob to select the wash program.

Turn this knob clockwise only.

To select a program, you should turn the knob so that the word/number of the desired program is in line with the pointer on the knob.

Now press on/off button **I** (position **I**), pilot lamp **L** will start flashing. After 5 seconds, the setting will be accepted, pilot lamp **L** will stop flashing (staying lit) and the wash cycle will begin.

If you want to interrupt the program in progress or set a new one, select one of the **Reset** positions and wait 5 seconds. When the cancellation has been accepted, pilot lamp **L** flashes, and you can then turn the appliance off.

You can use this knob to delay the appliance's operation.

Select one of the 4 delay time positions, press the on/off button **I** in and wait 5 min. The setting has now been accepted (pilot lamp **L** stays lit) and you can select the program you desire. Pilot lamp **L** has a particular flashing motion (2" on and 4" off) to indicate that a delayed start has been set.

During this phase, you can open the appliance door and change the washing load, should you wish to do so.

After the wash cycle has been set and accepted by the washer-dryer, turning the knob will have no effect (except for when it is on position **Reset** (Stop).

B Drying cycle knob

This control allows you to preset the drying time you want according to your requirements which may be "damp dry" ready for ironing, or "bone dry" ready for putting away. For more details see the drying time table on page 12. After all the controls have been correctly set, the dryer will start to operate as soon as you close the door.

C Temperature control knob

It is used to set the wash temperature in the recommended program table on pg. 11. It also allows you to reduce the temperature recommended for the selected program, and even to set a cold wash cycle.

D Detergent dispenser

It is divided into **3+1** sections:

1. Detergent for pre-wash;
2. Detergent for the main cycle wash;
3. Fabric conditioner;
4. Bleach.

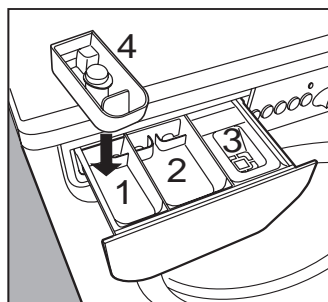

The detergent dispenser is here (for details see page 12).

E Prewash

With this button, you can pre-wash on all programs except the Wool program. (see page 11).

F Easy iron

This function allows your clothes to come out of the machine without wrinkling, making it much easier to iron. You can use it with **Permanent Press** and **Delicates** programs.

Press this button in such programs and the wash cycle will come to a stop on one position **Easy iron**. You can complete the cycle by pressing button **F** again.

Note: If you run a dry cycle, pressing this button the machine will not carry out the easy iron function.

G 1200 RPM Throttle Down

Use this button to reduce the spinning speed from 1200 to 600 rpm for the cotton and linen programs and from 850 to 450 rpm for the Permanent Press fabrics programs.

H Extra Rinse

This function adds one rinse cycle for **Cotton and Permanent Press fabrics**. Use of this function is recommended for improving rinsing results when washing

full loads and large quantities of detergent are used.

Recommended in case of detergent contact allergies.

I On-Off (Power)

To turn on the washer-dryer, press button **I** in. To turn off, press button **I** again so that it is out.

Turning the appliance off does not cancel the selected program.

L On-Off lamp / Door lock (Status)

Lamp **L** flashes slowly when the appliance is switched on and awaiting instructions and at the end of a cycle, indicating that the door can be opened. It flashes quickly when the door should not be opened. A steady light means the appliance has accepted the selected programme.

M Drying cycle lamp

When this lamp is on, it means that knob **B** has been set on a drying cycle and at the end of the wash cycle, the appliance will run the selected tumble drying cycle.

What are you washing today?



A program for all seasons

Type of fabric and degree of soil	Programme knob	Temperature knob	Pre-wash	Detergent for wash	Fabric softener	Bleach	Length of the cycle (minutes)	Description of wash cycle
COTTON HEAVY DUTY								
Exceptionally soiled whites (sheets, tablecloths, etc.)	1	Super	◆	◆	◆	◆	90	Wash cycle , rinse cycles, intermediate and final spin cycles
Heavily soiled whites and fast colors	2	Enhanced	◆	◆	◆	◆	50	Wash cycle , rinse cycles, intermediate and final spin cycles
Slightly soiled whites and delicate colors (shirts, jumpers, etc.)	3	NORMAL	◆	◆	◆	◆	40	Wash cycle , rinse cycles, intermediate and final spin cycles
Rinse cycles					◆		25	Rinse cycles, intermediate and final spin cycles
Spin cycle							13	Draining and final spin cycle
Drying cycle for cotton fabrics								Drying
Stop/Reset								Interrupts/Cancel the selected programme
PERMANENT PRESS								
Heavily soiled fast color synthetics (baby linen, etc.)	4	Standard	◆	◆	◆		80	Wash cycle , rinse cycles, anti-crease or delicate spin cycle
Delicate color synthetics (all types of slightly soiled garments)	5	Gentle	◆	◆	◆		65	Wash cycle , rinse cycles, anti-crease or delicate spin cycle
Delicate color synthetics (all types of slightly soiled garments)	6	Quick	◆	◆	◆		40	Wash cycle , rinse cycles and delicate spin cycle
Rinse cycles						◆	25	Rinse cycles, anti-crease or delicate spin cycle
Anti-crease					◆			Anti-crease /Stop with water in the tub
Spin cycle							10	Draining and delicate spin cycle
Drying cycle for synthetic fabrics								Drying
Stop/Reset								Interrupts/Cancel the selected programme
DELICATES (SYNTHETICS)								
Delicates	7	Handwash		◆	◆		64	Delicates , rinse cycles, anti-crease or draining
Silk, particularly delicate garments and fabrics (curtains, silk, viscose, etc.)	8	Silk	◆	◆	◆		60	Wash cycle , rinse cycles, anti-crease or draining
Wool	9	Wool		◆	◆		45	Wash cycle , rinse cycles and delicate spin cycle
Rinse cycles						◆		Rinse cycles, anti-crease or draining
Anti-crease								Anti-crease/Stop with water in the tub
Spin cycle								Draining and delicate spin cycle (Silk excluded)
Draining								Draining
Drying cycle for synthetic fabrics								Drying
Stop/Reset								Interrupts/Cancel the selected programme
DELAY START								
12 - 9 - 3 - 1 hour delay								Start is delayed by 12 - 9 - 3 - 1 hours
Stop/Reset								Interrupts/Cancel the selected programme

IMPORTANT: TO CANCEL THE WASH PROGRAM YOU HAVE JUST SET, SET THE WASHER KNOB TO THE "RESET" POSITION AND WAIT FOR AT LEAST 5 SECONDS.

The data found in the table are purely indicative, and can vary according to the quantity and type of washing, the water system temperature and the room temperature.

For more delicate garments: protect underwear, tights and stockings and delicate items by placing them in a linen bag

A combined Washing and Drying Program

How to dry

Combined (Wash&Dry)

- Look at table **A** to the side and follow the instructions provided for **MAX** load to have an **automatic** washing and drying cycle.
- Follow the instructions for **wash only** (see page 9, the section "Starting the Washer-Dryer")
- Set the dryer time on **Dryer** knob.
- Press the **Power** button.

If the laundry load to be washed and dried exceeds the maximum load (see table A), then:

- follow the instructions provided for **wash only** (page 9, in section "Starting the Washer-Dryer" and follow these instructions.

- when the wash cycle has finished, remove your washing, divide it up and replace part of it inside the drum.

Now follow the instructions provided for a **dry only** cycle. Repeat this procedure for the remainder of the load.

Dry only

- Load the clothes no more than 2/3 full (**8 lbs/3.5 kg**) for cottons, (see table for other fabrics), make sure that:
 - the door is shut correctly;
 - the plug is inserted in the socket;
 - the water tap is turned on;
 - Power button has not been pressed (**O** position).

• Set the **Washer** knob to the appropriate **"OFF"** setting depending on the type of fabric

• Set dryer time on the **Dryer** knob

• Press **Power** button to start.

When Drying is Complete... Mode+ Lock light flashes slowly. Turn the washer-dryer off by pressing the Power button (**O** position). Now you can open the appliance door. Once you have removed the dry clothes from the appliance, leave the door open or ajar to avoid the formation of bad odors and turn off the water (if attached with a faucet adapter kit.)

The drying time depends largely on the type of material (some fibers absorb more water than others), on the dampness of the articles when the drying is started and on the amount of the laundry. Table napkins, towels and similar (rather thick) articles will take a long time to dry.

Table A.

Fabric type	Load type	Max. load Lbs (kgs)	Drying time (minutes)		
			Extra Dry	Ward-robe	Iron
- Cotton, - Linen	Clothing of different sizes	8 (3.5)	100	90	80
- Cotton	Terry towels	8 (3.5)	100	100	90
- Terital, - Cotton	Sheets, Shirts	5 (2.5)	80	70	60
- Acrylics	Pyjamas, socks, etc.	2 (1)	60	50	50
- Nylon	Slips, tights, stockings, etc.	2 (1)	60	50	50

The data contained in the table are purely indicative.

WARNING

- During the drying phase, the door tends to get quite hot.
- Do not use the appliance to dry clothes that have been washed with flammable or chemical solvents (e.g. trichlorethylene).
- Do not use the appliance to dry foam rubber or similar elastomers.
- Make sure that the cold water faucet is turned on during the drying cycles.
- This washer-dryer can only be used to dry clothes which have been pre-washed in water.

IMPORTANT

A spin cycle is carried out during the drying if you have set a **cotton program**.

For cotton loads of less than 2 lbs (1 Kg), use the drying program designed for synthetic fabrics.

Useful tips

■ **Never use your washing machine to wash...** torn, fraying or non-hemmed linen. If it is absolutely necessary, place it in a bag for protection. Do not wash colored linen with whites.

■ Watch the weights !

For best results, do not exceed the weight limits stated below (figures show weight of dry garments):

- **Resistant fabrics:** 12 lbs (5.5 kg) maximum
- **Synthetic fabrics:** 6 lbs 10 oz (3 kg) maximum
- **Delicate fabrics:** 5 lbs 8 oz (2.5 kg) maximum

■ Pure new wool:

- 2 lbs (1 kg) maximum
- **Bathrobe:** 5 lbs 8 oz (2.5 kg) maximum

■ How much does it weigh?

- 1 sheet 1 1/4 lb (400-550 gr.)
- 1 pillow case 4 oz. (120 gr.)
- 1 tablecloth 1 lb (450 gr.)
- 1 bathrobe 2-3 lbs (900-1,300 gr.)
- 1 towel 5oz/1 lb (150-500 gr.)

■ **Colored T-shirts**, printed ones and shirts last longer if turned inside out before washing. Printed T-shirts and sweatshirts should always be ironed inside out.

■ Denim Alert.

Some overalls have straps with hooks that can damage the drum of your washing machine or other garments during the wash. To minimize the risk, place hooks in the pocket and fasten with safety pins.

■ Vacations: unplug the appliance.

It is recommended that you should unplug the machine from the socket and turn off the water supply. Leave the door ajar to allow air circulation to the draw and the door gasket area. This will prevent unpleasant odours.

For more delicate garments: protect underwear, tights and stockings and delicate items by placing them in a linen bag

WOOLCYCLE

For best results, we recommend you use very little detergent, taking care not to wash more than **2 lbs (1kg)** of laundry.

Stain Removal Chart

Blood

Rinse or soak fresh stain in cold water. Work detergent into any remaining stain. Rinse. If stain persists, put a few drops of ammonia on stain and repeat detergent treatment. Rinse. If necessary bleach.

Candle Wax

Scrape off excess. Place stain between clean white blotters or several layers of facial tissues. Press with warm iron. Sponge with cleaning fluid. If dye spot remains, bleach.

Ketchup

Scrape off excess. Soak in cold water 30 minutes. Pretreat with a detergent paste. Launder.

Chewing Gum

Rub with ice to harden. Scrape off excess with dull blade. Sponge with cleaning fluid.

Chocolate or Cocoa

Soak 15 minutes in cold water. Rub detergent paste into stain, then rinse thoroughly. Launder in hottest water safe for fabric. If colored stain remains, sponge with hydrogen peroxide, rinse and launder.

Cod liver Oil

Sponge article with cleaning fluid. Soak in warm suds. If stain persists, wash with bleach safe for fabric. To remove yellow stain, sponge with hydrogen peroxide. Rinse and launder. Old stains may be nearly impossible to remove.

Coffee or Tea (Black)

Soak fresh stains immediately in cold water. Then use bleach treatment with hottest water safe for fabric. Or if safe for the fabric pour boiling water through spot from a height of 1 to 3 feet. Launder.

Coffee or Tea (With Cream)

Rinse or soak in cold water. Work detergent into stain. Rinse. Dry. If grease stain remains, sponge with cleaning fluid. Repeat, if necessary. If stain remains, bleach.

Cosmetics: eye shadow, lipstick, liquid make-up, mascara, powder, pancake make-up or rouge

Apply undiluted liquid detergent to stain, or dampen stain and rub in soap or detergent paste until thick suds are formed. Work in until stain is gone, rinse well. Repeat if necessary. If color remains, bleach if safe for fabrics.

Cream, Ice Cream or Milk

Sponge stain with cool water or soak stain in cool water for 30 minutes or longer. If stain remains, work a detergent in- to spot then rinse. Bleach if necessary.

Deodorants and Antiperspirants

Wash or sponge stain thoroughly with warm water and detergent; rinse. If stain remains, bleach with hot sudsy water. Launder. You may be able to restore fabric color by sponging with ammonia. Rinse thoroughly.

Dye

Rinse or soak in cold water. Work detergent into stain. Rinse. If necessary, bleach. Stain is not always possible to remove. A commercial color remover may also be used.

Egg or Meat Juice

Rinse in cold water. If stain remains, sprinkle with meat tenderizer, let stand 15-20 minutes. If stain still remains, sponge with cleaning fluid or diluted bleach. Launder in hot water. The use of hot water first may set stain.

Fabric Softener Stain

Rub with bar soap until stain has lightened. Rinse thoroughly. Launder. Rubbing alcohol is sometimes effective in the color of the garment can take it. Launder. If desired, dry cleaning can be used.

Felt tip pen

Spray spot with cleaners suitable to this purpose. Sponge stain thoroughly. Rinse with cold water. Reapply cleaner if necessary.

Fruit, Wine

Soak fresh stains immediately with cool water. Then use bleach treatment with hottest water safe for fabrics, pour boiling water through spot from a height of 1 to 3 feet. Launder.

Grass

Work detergent into stain. Sponge with denatured alcohol. Bleach, if necessary.

Grease or Oil

Scrape away excess. Rub detergent paste or a general purpose liquid household cleaner into stain, rinse with hot water. If stain remains, sponge thoroughly with a grease solvent. Dry. Repeat if necessary. To remove yellow stain, use a chlorine or oxygen bleach.

Ink. Ball-point

Same ball-point inks are set by water. First test a scrap of cloth. Sponge stain repeatedly with acetone, amyl acetate or rubbing alcohol. Hair spray is effective. Launder. Bleach if necessary. Use amyl acetate on triacetate, arnel, dynel and verel. Use acetone on other fabrics.

NOTE: Some inks cannot be removed.

Mildew

Brush off surface growth to keep mold spores from spreading. Dip article into solution of 1/2 cup bleach per 1 gallon of cool sudsy water for 5 to 10 minutes. Rinse well. Launder.

Mud

Let stain dry; then brush well. Rinse repeatedly in cool water until mud comes out. Launder. (Hot soaps suds set a red or yellow clay stain).

Mustard

Soak in hot detergent water for several hours. If stain remains, bleach.

Nail Polish

Treat while fresh, scraping or wiping off as much as possible, before it dries. Place stain face down on white paper towels. Sponge back of stain acetone (nail polish remover) or sponge with denatured alcohol and a few drops of household ammonia. Sponge stain frequently. Launder with water at temperature suitable for fabric.

Do not use acetone on acetate, arnel, dynel or rayon.

Paint

Sponge or soak in turpentine or solvent recommended as a thinner on label. Launder.

Perfume

Rinse in cold water. Rub undiluted liquid detergent or a detergent paste into stain. Rinse. If stain remains, bleach.

Perspiration

Wash or sponge stain thoroughly with warm water and detergent paste. If perspiration has changed the color of the fabric, restore it by treating with ammonia or vinegar. Apply ammonia to fresh stains; rinse with water. Apply vinegar to old stains; rinse with water.

Rust and Iron

Apply commercial rust remover, according to manufacturer's directions. Rinse. Or, if safe for fabric, boil stained article in solution of 4 teaspoons of cream of tartar to 1 pint water.

Scorch

Rinse or soak in cold water. Work detergent into stain. Rinse. Bleach, if necessary. Stain may be impossible to re move.

Urine

Soak in cool water. If stain is dry, work a detergent paste into the spot then rinse. If necessary, bleach.

Shoe

Polish Scrape off as much as possible. Pretreat with a detergent paste; rinse. If stain persists, sponge with rubbing alcohol (1 part to 2 parts water) or turpentine. Remove turpentine by sponging again with warm detergent solution or with alcohol. Bleach if necessary.

Soft Drinks























Sponge with cold water, some stains are invisible when they have dried, but turn brown when heated and may be impossible to remove.

Tar and Asphalt

Act quickly before stain is dry. Sponge with grease solvent or turpentine. Launder.

UNDERSTANDING FABRIC CARE LABELS

The symbols on labels of your garments will help you in choicing the suitable wash program, the right temperature, wash cycles, and ironing methods. Don't forget to give a glance to these useful indications !

Machine Wash Cycle	 Normal/ Cotton Heavy Duty	 Permanent Press/ wrinkle resistant	 Delicate/ Gentle	 Hand wash	 Do not wash	 Do not wring
Water Temp.	 Hot (50°C/120°F)		 Warm (40°C/105°F)		 Cold/Cool (30°C/85°F)	
Tumble Dry	 Dry	 Normal/ Cotton Heavy Duty	 Permt Press/ wrinkle resistant	 Delicate/ Gentle	 Do not tumble dry	 Do not dry
Special Instructions	 Line dry/ hang to dry	 Drip dry	 Dry flat	 In the shade		
Bleach Symbols	 Any bleach (when needed)	 Only non-chlorine bleach (when needed)		 Do not bleach		

Select the right temperature...

Look !



RIGHT

Turn off the water supply after use. This will eliminate the possibility of leakage.

Always leave the appliance door ajar to avoid bad odours.

Clean the appliance's exteriors gently. To clean the exteriors and the rubber parts of the appliance, always use a soft cloth dipped in warm and soapy water.

WRONG

Leave the washing machine plugged in while cleaning. Even during maintenance, the appliance should always be unplugged.

Use solvents and aggressive abrasives. Never use solvents or abrasives to clean the external and rubber parts of the washing machine.

Neglect the detergent dispenser. It is removable and can easily be cleaned by leaving it under running water.

Go on holiday without thinking about her. Before leaving, always make sure that the washing machine is unplugged and that the water supply is turned off.

It's important for a good wash

Useful tips about the detergent dispenser

The first secret is the easiest: the detergent dispenser is opened by pulling it out.

You must follow the quantity recommendations provided by the manufacturers when adding detergent or fabric softener. Quantities will vary according to the wash load, the water hardness and how soiled the clothes are.

Experience will help you select the right quantity almost automatically.

Before adding detergent for pre-washing in compartment **1**, make sure that the extra compartment for bleach **4** has not been inserted.

Ensure no overfilling when adding fabric conditioner in compartment **3**.

The washing machine automatically adds the softener to the wash in each program.

Liquid detergent is poured into compartment **2** just a few seconds before starting the wash cycle.

Remember that liquid detergent is only designed for wash cycles of up to 60 degrees on non pre-wash items.

Special containers are sold with liquid or powder detergents for placing inside the washing machine drum, these are positioned according to the instructions found in the detergent box

Never use hand wash detergent, because it may form too much foam, which could damage the washing machine. Detergents that are specifically formulated for both hand and machine wash are an exception.

One last secret: when washing with cold water, always reduce the amount of detergent you use: it dissolves less easily in cold water than in hot water, so part of it would be wasted.

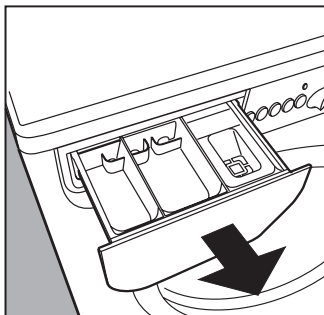

Detergent dispenser cleansing

The detergent dispenser can be removed and cleaned: pull it outwards, as indicated in the figure. Then leave it under warm running water for a few minutes.

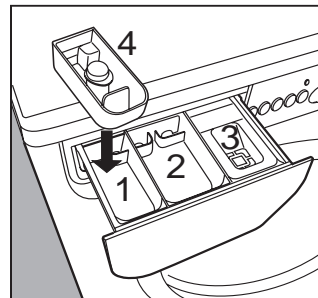

In compartment **1**:
Detergent for pre-washing (powder)

In compartment **2**:
Detergent for washing (powder or liquid)

In compartment **3**:
Additives (softeners, perfumes, etc.)

In compartment **4**:
Bleach and delicate bleach.

But where did all the water go?

Simple: with the new technology, you need less than half of it, to get good results on twice as much!
This is why you cannot see the water through the door: because there is little, very little of it, to respect the environment yet without renouncing maximum cleanliness.

And, on top of that, you are also saving electricity.



Bleach cycle and stain removal button

If bleaching is necessary, the extra case **4** (provided) must be inserted into compartment **1** of the detergent dispenser. When pouring in the bleach, be careful not to exceed the "max" level indicated on the central pivot (see illustration).

The use of the additional bleach container excludes the possibility of using the pre-wash cycle.

Traditional bleach can only be used on sturdy white fabrics, whereas delicate bleach can be used for colored fabrics, synthetics and for wool.

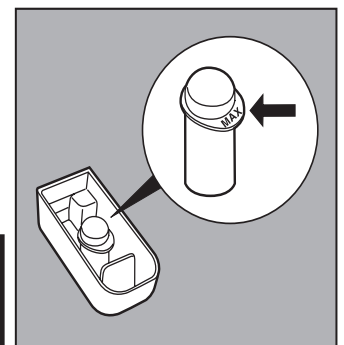

You cannot bleach with the "Silk" program. (See page 11).

NOTE: BLEACH ONLY WORKS WITH HOT WASH TEMP.

Troubleshooting

Before calling, read the following

In most cases, when your washer-dryer fails to work, the problems arising can be easily solved without having to call for a technician. Before calling for assistance, always check these points.

The washer-dryer fails to start.

■ **Is the plug correctly inserted into the socket?** It could have been moved while cleaning.

■ **Is there electricity in the house?**

A circuit breaker may have switched off as a result of too many electrical appliances working at the same time. Or maybe due to a general failure in your entire area.



■ **Is the washer-dryer door closed properly?**

For safety reasons, the washer-dryer cannot work if the door is open or not shut properly.

■ **Is the On/Off button pressed?**

If it is, then a program has been set.

WARNING !

WINTERIZING YOUR WASHER/DRYER

To winterize your washer/dryer please, follow the instructions below to avoid damage to your unit due to freezing:

1. With the unit off, remove wash filter. This will allow the water remaining in the pump and drain hose to be evacuated. Replace filter.
2. Close the inlet shut-off valves (provided by installer) and disconnect the inlet hoses. There should be no water in the hoses where they attach at the back of the machine.

IF ANTIFREEZE IS BEING USED IN THE SYSTEM FOLLOW THESE INSTRUCTIONS:

(not necessary if the above drain procedure is followed)

1. When putting antifreeze into the water system of your coach, set the washer to a warm/warm fill setting and allow water to flow into unit until antifreeze is detected.
2. Advance the knob timer on "Reset", turn on "Rinse" position and allow water to flow for 10 seconds.
3. Advance the knob timer on "Reset" and then turn again on "Spin" to remove the majority of the water from the unit.
4. With the unit off, remove wash filter from unit. This will allow the water remaining in the pump and drain hose to be evacuated. Replace filter.
5. If you elect you may close the inlet shut-off valves (provided by installer) and disconnect the inlet hoses.
6. Any water remaining in the unit should contain antifreeze and be protected from freezing.

Note: When placing unit into service allow unit to operate for one complete cycle before doing laundry to ensure all antifreeze has been purged from the unit.

If you have any further questions pertaining to this matter please call **Equator Technical Support Toll free at (888) 935-1565.**

■ **Is the Washer knob in the correct position for those models concerned?**

■ **Is the water supply turned on?** For safety reasons, if the washer-dryer does not load water, it cannot start a wash cycle.



The Washer knob keeps turning?

■ **Wait a few minutes for the drain pump to empty the tub,** switch the washer-dryer off, select one of the positions stop/**OFF**, then switch it back on. If the knob continues to turn, call for assistance because it is showing an anomaly.



The washer-dryer fails to fill with water.

■ **Is the hose correctly connected to the tap?**

■ **Is there a water shortage ?** There could be work in progress in your building or street.

■ **Is there sufficient water pressure?** The autovalve may be malfunctioning.

■ **Is the tap filter clean?** If the water is very calcareous, or if work has recently been carried out on the water piping, the tap filter could be clogged with particles and debris.

■ **Is the rubber hose kinked?** The rubber hose bringing water to washer-dryer must be as straight as possible. Make sure it is not squashed or kinked.

The washer-dryer continuously fills and drains water.

■ **Is the drain hose positioned too low?** It must be installed at a height ranging from 25" to 34" (62 to 86 cms.).

■ **Is the end of the hose immersed in water?**

■ **Does the wall drainage system have a breather pipe?** If the problem persists even after these checks, turn the water supply off the machine and call for assistance.

If you live on an upper floor of your building, there may be a problem with your drain trap. To solve this problem, a special valve must be installed.

You will be charged for a service call while the appliance is in warranty if the problem is not caused by defective workmanship or materials.



The washer-dryer does not drain or spin.

■ **Does the selected program incorporate water draining?** Some programs stop at the end of the wash cycle and draining will have to be selected manually.

■ **Is the "Easy Iron" function -where provided - enabled?** This function requires manual selection for draining.

■ **Is the drain pump clogged?** To check it, turn off the water supply, unplug the washer-dryer and follow the instructions on page 18, or call technical support.

Always get assistance from authorized service agent and always insist on original spare parts.

Cleaning Filters

Remove filters using tweezers, clean and replace

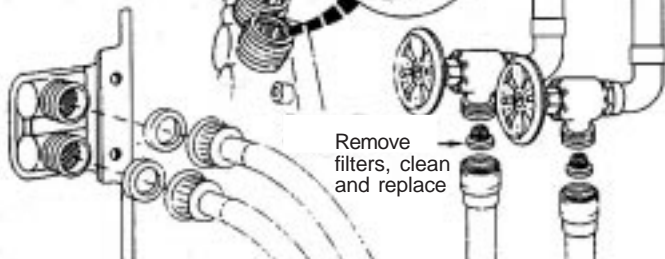

Drain: to avoid flooding be careful to adjust the drain hose to at least 25" above the base of the appliance.

Fasten the hoses securely.

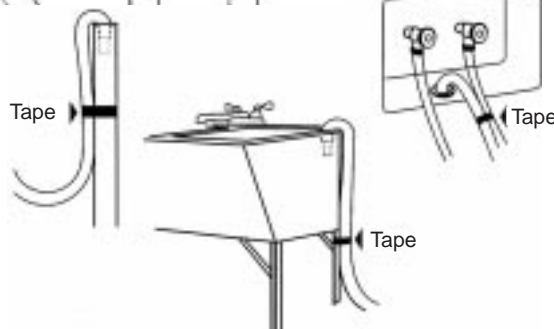

■ **Is the drain hose kinked?** The drain hose must be as straight as possible. Make sure the drain hose is not crimped or kinked.

■ **Is the washer-dryer's drain hose clogged?** Is there an extension of the drain hose? If so, is it positioned incorrectly, blocking the water flow?



Excessive vibration during the spin cycle.

■ **Have all shipping bolts been removed during installation?** See the following page on installation procedures.

■ **Has the washer-dryer been levelled correctly?** The levelling of the appliance should be checked periodically. Adjust the feet and check them with a level.

■ **Is there space between the machine and adjacent units?** If it is not a built-in model, the washer-dryer will oscillate a bit during the spin cycle. A few cm of space should therefore be left around it.



The washer-dryer leaks.

■ **Is the metal ring of the inlet hose properly attached?** Turn off the water supply, unplug the appliance and try tightening its attachment without forcing it.

■ **Is the detergent dispenser obstructed?** Remove and wash it under tap water.

■ **Is the drain hose well attached?** Turn off the water supply, unplug the appliance and try tightening its attachment.



Too much foam.

■ **Is the detergent appropriate for machine washing?** Check whether the definition on its label reads "for machine wash" or "hand and machine wash", or any other similar wording.

■ **Is the correct amount being used?** An excessive amount of detergent, besides producing too much foam, does not guarantee a more effective wash, and causes scaling in the internal parts of the appliance.

The washer-dryer does not dry.

■ **Check whether:** the plug has been correctly inserted into the socket; there is electricity in your home; the appliance door has been shut properly; a delayed start (if available) has not been selected; program knob **A** has been set to **Reset** and the drying cycle knob **B** has been set to position **0 minutes**.

The washer-dryer doesn't dry properly.

■ **Check whether:** **1)** the end of the drain hose is underwater; **2)** the drain pump is obstructed; **3)** the advice given on the maximum loads has been taken; **4)** the water tap has been turned on.

If, despite all checks, the washer-dryer fails to function and the problem persists, call your nearest authorized Customer Service Centre, providing the following information:

- the nature of malfunction
- the model type no. (Mod.)
- the serial number (S/N)

This information can be found on the data plate situated at the back of the washer-dryer.

Easy Care and Maintenance

Treat your machine well and it will provide many years of trouble free service

Your washer-dryer is a reliable companion in life. It is just as important for you to keep it in shape.

Your washer-dryer is designed to provide reliable service over many years. A few simple steps will help to extend its life and avoid problems. It is advisable to turn off water faucets when the machine is not in use. This protects the hoses, etc.

If the water in your area is hard, use a water softener (hard water often leaves white stains around taps or drains, especially in bath tubs. For more accurate information about the type of water in the system, call your local water utility).

Pockets must always be emptied, removing pins, badges, coins, or any other hard objects.

CLEANING THE EXTERIOR

The washer-dryer exterior should be cleaned with a rag dipped in lukewarm water and soap. Do not use polish of any kind on the plastic trim. Some polishes contain agents which can damage plastics.

Cleaning the interior

If you live in an area where phosphate detergents are banned, it may be necessary

to recondition the washer periodically. Because a non-phosphate detergent must be used, body oils and detergent may accumulate in the washer tub. This is particularly evident in hard water areas or in homes where heavily soiled garments are regularly laundered. To remove this build-up, run the washer through a complete cycle using hot water and 2 cups of a non precipitating water conditioner. Do not add any clothes, detergent, or other laundry aids.

Once the accumulation has been removed, your laundry should be satisfactory if you follow the preventive suggestions in this owner's manual.

GENERAL MAINTENANCE

After washing is complete the water faucets should be turned off to relieve water pressure on the hoses.

Wipe the inside of the door with a soft cloth to remove any remaining moisture. Periodically, a thin coat of paste wax should be applied to the inner door or the washer;

especially to the area which is immediately next to the door window. This will protect the door finish from laundry aid spills and any discoloration which may result of these spills.

Clear the Coin Trap

Clear the coin trap in case of blockage. For instructions, please read the section below.

Never add too much detergent.

Detergents already contain deliming agents. Only if the water is particularly hard, that is, rich in lime content, do we recommend the use of a specific product at every wash.

A periodical wash cycle with a dose of a deliming product, without detergents or washing, may prove useful.

Never use too much detergent or additives because this could cause excessive sudsing, scaling, and possible damage to components in your washer-dryer.

It is important to wash the detergent dispenser regularly. To prevent dried washing powder from accumulating, place the dispenser under running water for a few minutes.

Use only low-sudsing detergents.

If one is not available at your local grocery store, contact Equator at 1-800-935-1955 to order a box.



Do not forget to empty all pockets: small objects can cause serious damage to your washer-dryer.

When in need, check the pump and the rubber hose.

The washer-dryer comes equipped with a self-cleaning pump that does not require any cleaning or maintenance. Small objects may accidentally fall into the pump: coins, hair clips, loose buttons, etc. To avoid possible damage, they are withheld in an accessible coin trap, located at the bottom right end of the machine.

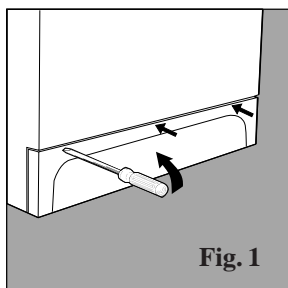

Fig. 1

Attention: Before attempting to examine this coin trap, first ensure that the machine has finished its program and is empty. Unplug the machine, as with any maintenance.

To gain access, gently ease down the top of the kick plate panel at the base of the machine with a screwdriver etc, to release it. Then ease the top edge forward to allow it to be lifted clear (Fig. 1). Place a shallow dish or tray below the cover of the pre-chamber to catch any water that might be present. Open the cover by turning it counter-clockwise (Fig. 2). When finished cleaning, ensure that the cover is securely tightened.

Re-fit the kick plate cover by inserting the hooks on its lower edge into the slots and ease the top edge back into position.

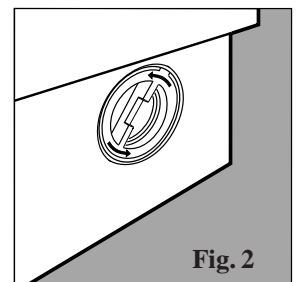



Fig. 2

The water inlet hose

Check the rubber hoses at least once a year. If you see any cracks, replace the hose immediately. When you use your washer-dryer, water pressure is very strong and a cracked tube could easily split open. Superior quality Stainless Steel hoses are also available for purchase. Call Equator Parts at 1-888-483-9627 to order.

Technical characteristics

Model	EZ 3612 CEE	Washer- dryer	Ventless
Dimensions	width 23.4" (59.5 cm) height 33.4" (85 cm) depth 23.4" (59.5 cm)		
Capacity	1.92 cu.ft		
Electrical connections	voltage 120 Volt 60 Hz (minimal working 108 volt) maximum absorbed power 1350 W, 13 A.		
Water connections:	maximum pressure 100 psi (689.6 kPa) minimum pressure 20 psi (137.9 kPa)		
Spinning speed	up to 1200 rpm		
This appliance conforms with the  directives for USA and Canada			

As a result of technological progress, the manufacturer reserves the right to make any improvements to its appliances without giving prior notice to its clientele.

EQUATOR CONTACT NUMBERS

SERVICE: (800) 776-3538

PARTS & ACCESSORIES:(888) 483-9627

TECHNICAL SUPPORT: (888) 935-1565



Equator Corporation,
Equator Plaza,
2801 W. Sam Houston Parkway N.
Houston, Texas 77043
Tel: 713-464-3422 • Fax: 713-464-2151
Toll Free: 800-935-1955

Printed in Italy. All rights reserved.
Manual subject to change without notice